



Air Handling Unit Technical Data

Modular T



ASTRA WEB Version 10.1.13.1

Index

1. Features.....	4
2. Unit Description and configurations.....	5
3. Standard material name – base module	6
4. Specifications.....	7
4.1. Technical Data	7
4.1.1. Nominal Data.....	7
4.1.2. Sectioning	8
4.1.3. Nominal Air Flow	11
4.2. Electrical Data.....	11
4.3. Declaration EU. REG. 1253/2014.....	12
4.4. Bearing structure	13
4.5. Insulation	13
4.6. Heat Exchanger.....	13
4.7. Fans.....	13
4.7.1. Pro Version	13
4.7.2. Smart Version	13
4.8. Filters	14
4.9. Control system.....	15
4.9.1. Pro Controls	15
4.9.2. Smart Controls.....	16
4.10. Default Values	17
4.10.1. Pro Version	17
4.10.2 Smart version.....	18
4.11. Antifreeze Logic	19
4.11.1. Pro Version	19
4.11.2. Smart Version	20
4.12. Operating Limits	22
4.12.1. Pro Version	22
4.12.2. Smart Version	23
5. Accessories	24
5.1. Accessories list.....	24
5.2. Accessories for Pro & Smart version	26
5.2.1. Filters	26
5.2.2. Silencers.....	27

5.3. Accessories only for Pro version.....	27
5.3.1. Useful information.....	27
5.3.2. Coils	28
5.3.3. Valves.....	31
5.3.4. Dampers	32
5.3.5. Electrical accessories	32
5.4. Accessories only for Smart version.....	33
5.4.1. Coils	33
6. Performance	34
6.1. Performance data	34
6.2. Thermal efficiency	37
6.3. Sound emission.....	39
6.4. Dimensional Drawings	44

1. Features

Heat recovery unit with top connections for decentralised ventilation system

- Available in 5 sizes with an air flow from 200 m³/h up to 4200 m³/h, ErP 2018 compliant
- More than 500 Pa of external static pressure, depending on model size and conditions
- Smallest size is 550 mm wide, while the biggest size only 890 mm
- Energy saving solution thanks to the 100% automatic bypass
- Reduced energy consumption thanks to EC fan technology and IE5 motor efficiency
- Free-cooling operation and energy efficient defrost logic
- Aluminium counter flow plate heat exchanger with efficiency up to 93%
- Up to three filters on supply side, up to ePM2.5 50% (M5) + ePM1 50% (F7) + ePM1 80% (F9)
- CO2 level management thanks to optional CO2 sensor
- 50 mm double skin panels, mineral wool insulated
- Modbus and BACnet compatible (accessory)
- DX, water and electric coil available as option
- Mixing damper to allow mix/recirculated air operation, available as accessory
- Ideal solution for light commercial applications as: retail shops, small and large offices, hotels, gyms, cinemas, theatres, school, colleges, universities, etc
- Left or right hand version
- Smart (Daikin F1-F2/P1-P2 communication protocol) or Pro (Open protocol) version



2. Unit Description and configurations

Modular T is available in two configurations for connection side, right and left (looking to the position of supply air flow standing in front of the installed unit).

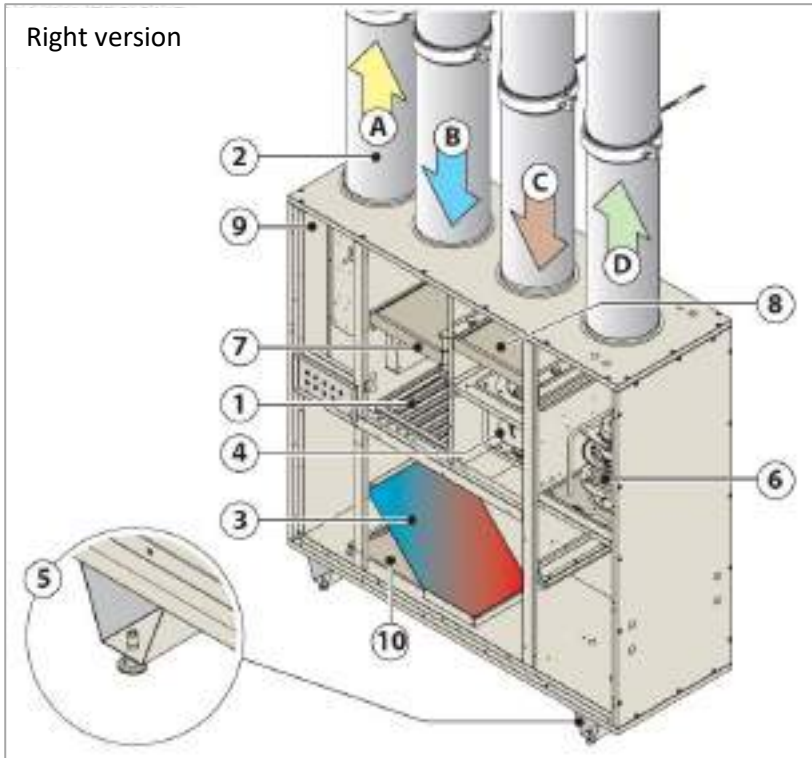

Components:

1. Bypass damper
2. Ducts
3. Heat Exchanger
4. Return fan
5. V – Shaped feet
6. Supply fan
7. Supply filter
8. Return Filter
9. Control
10. Drain Pan

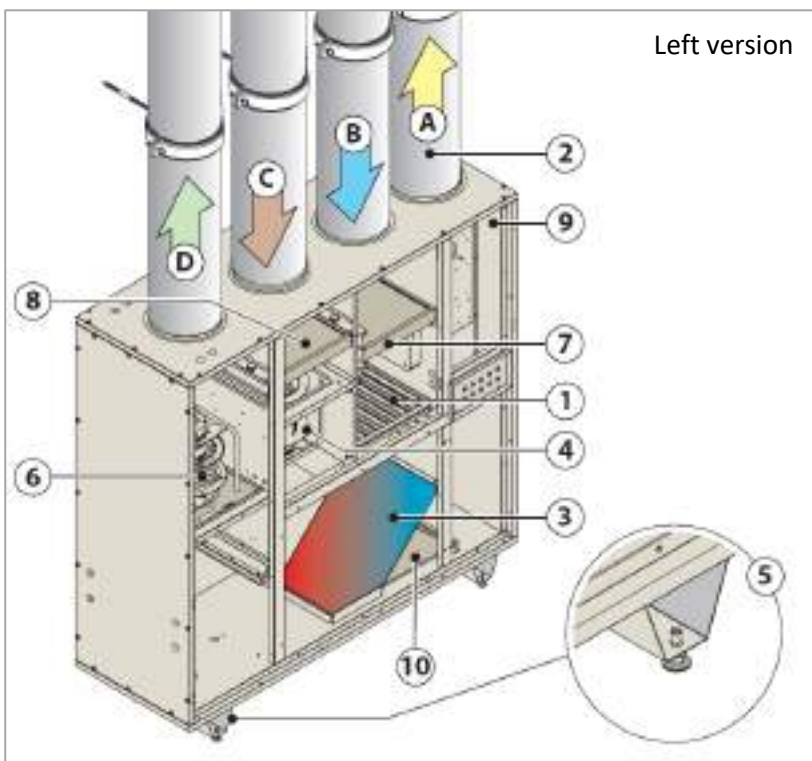

Airflow direction

- A. Exhaust air
- B. Fresh air
- C. Return air
- D. Supply air

3. Standard material name – base module

Digit	Product		Components	Size		Connection side	Model revision	Controls
	1	2	3	4	5	6	7	8
	A	T	B	0	3	R	A	M
Character	A = AHU	T = Modular T	B = Base module	03 = Size 03 04 = Size 04 ... 07 = Size 07		R = Right L = Left	A = First release B = Second release	M = Pro solution S = Smart solution

Standard unit is provided with:

- Aluminium counter flow plate heat exchanger
- EC Fan with IE5 motor efficiency class
- ePM1 50% (F7) filter on supply air
- ePM10 75% (M5) filter on return air
- Double skin panel (inner Aluzinc AZ185, outer pre – painted)
- Control:
 - Pro version: programmable controller
 - Smart version: Smart controller (VAM control)

For Pro version, the room thermostat and user interface ALC00822A is included with the main unit.

For Smart version, the BRC thermostat/remocon is not included with the main unit and has to be provided separately.

Nomenclature:

Modular T Pro	Main Unit	
	Right	Left
Size 03	ATB03RA	ATB03LA
Size 04	ATB04RA	ATB04LA
Size 05	SB.ATB05RA	SB.ATB05LA
Size 06	SB.ATB06RA	SB.ATB06LA
Size 07	SB.ATB07RA	SB.ATB07LA

Modular T Smart	Main Unit	
	Right	Left
Size 03	ATB03RAS	ATB03LAS
Size 04	ATB04RAS	ATB04LAS
Size 05	SB.ATB05RAS	SB.ATB05LAS
Size 06	SB.ATB06RAS	SB.ATB06LAS
Size 07	SB.ATB07RAS	SB.ATB07LAS

SB. = Sales Bom: sales tool used for Make to stock products shipped in two or more sections.

4. Specifications

4.1. Technical Data

4.1.1. Nominal Data

	Material Name ¹	ATB03*A*	ATB04*A*	SB.ATB05*A*	SB.ATB06*A*	SB.ATB07*A*
	Size	03	04	05 ²	06 ³	07 ³
Airflow	m3/h	800	1650	2300	2700	3900
HE Thermal efficiency ⁴	%	89,3	88,3	85,1	85,5	90,8
External static pressure	Pa	100	100	100	100	100
Current	A	1,7	3,39	4,61	5,17	7,87
Power input	kW	0,39	0,78	1,06	1,19	1,81
SFPv	kW/m3/s	1,47	1,5	1,49	1,41	1,5
Electrical supply	Phase (ph)	1				
	Frequency (Hz)	50 - 60				
	Voltage (V)	220 - 240				
Main unit Dimensions	Width (mm)	550	790	790	790	890
	Height (mm) ⁶	1600	1600	1900	1850	2050
	Length (mm)	1580	1650	2170	2620	2950
Circular duct flange	Diameter (mm)	250	315	355	400	500
Unit sound power level	dB(A)	57	52	55	55	58
Unit sound pressure level ⁷	dB(A)	50	45	48	48	51
Net Weight Unit	kg	200	250	400	500	620

1. For ATB03*A* we refer to all the versions of Modular T size 03 (left or right and Smart or Pro)
2. Size 05 is provided in two sections (600mm + 1570mm).
3. Size 06 and 07 are provided in three sections (710mm + 1430mm + 480mm) and (810mm + 1560mm + 480mm).
4. Outdoor air condition: -5°C/90%, extract air condition: 25/50%
5. Height of the unit taking into account the feet, mounted on site, (100mm) and duct joints (50mm)
6. Sound pressure at 1m with in (directivity factor Q = 4) in non reverberant field. Allowances on declared values: +/- 3dB.

4.1.2. Sectioning

To ensure an easy and quick transportation and installation biggest sizes are provide in more sections. The following table summarize the number of sections for each size.

Material Name	Size	Number of sections
ATB03*A*	03	1
ATB04*A*	04	1
ATB05*A*	05	2
ATB06*A*	06	3
ATB07*A*	07	3

For the units provided in more sections, size 05, 06 and 07, there is an easy rule to follow up, to identify the position of the sections, valid for both right and left version of the unit.

Section 1 always refer at supply air flow while section 2 contains the heat exchanger. In this way for right version, the section 1 is on the right of section 2, while for left version it is on the left.

For size 06 and 07, that are divided into three sections, the third one is the control section. It will be installed on the left of section 2 for right version and on the right of the section 2 for left version.

Section and size	Length (mm)	Width (mm)	Height (mm)	Net Weight (kg)	Gross Weight (kg)
Main unit, size 03	1580	550	1600	200	210
Main unit, size 04	1650	790	1600	250	260
Section 1, Size 05	600	790	1900	130	140
Section 2, Size 05	1570	790	1900	270	280
Section 1, Size 06	710	790	1850	140	150
Section 2, Size 06	1430	790	1850	260	270
Section 3, Size 06	480	790	1850	100	110
Section 1, Size 07	810	890	2050	180	190
Section 2, Size 07	1560	890	2050	320	330
Section 3, Size 07	580	890	2050	120	130

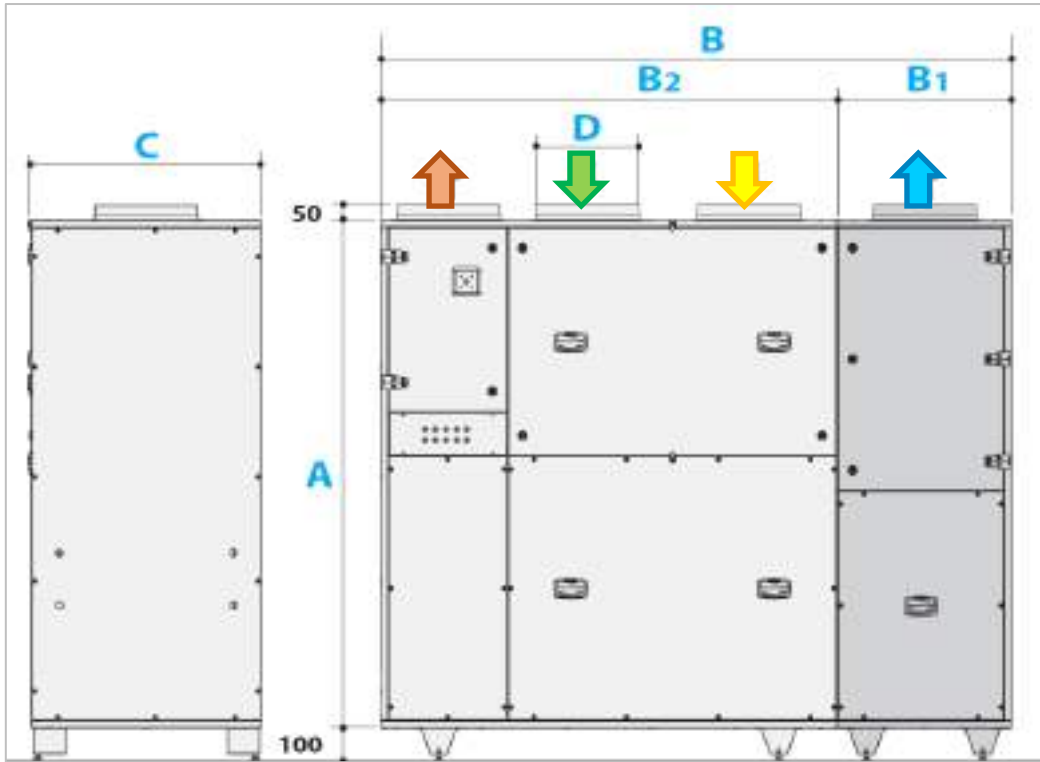

Size 05 – Right configuration

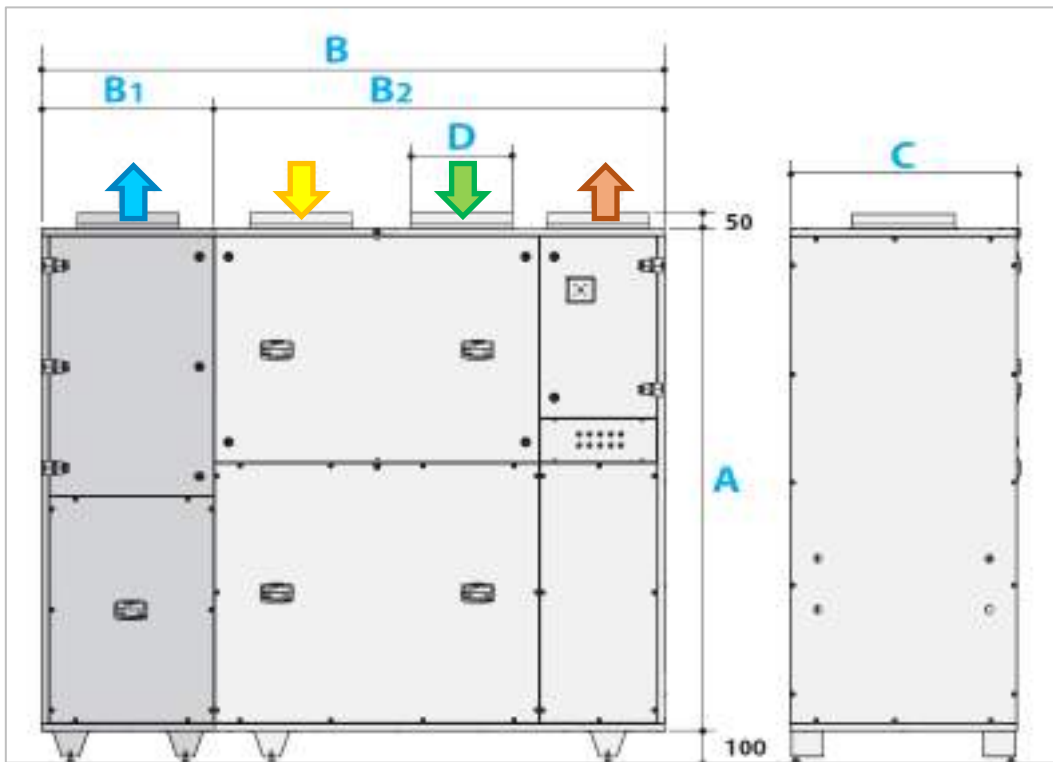

Size 05 – Left configuration



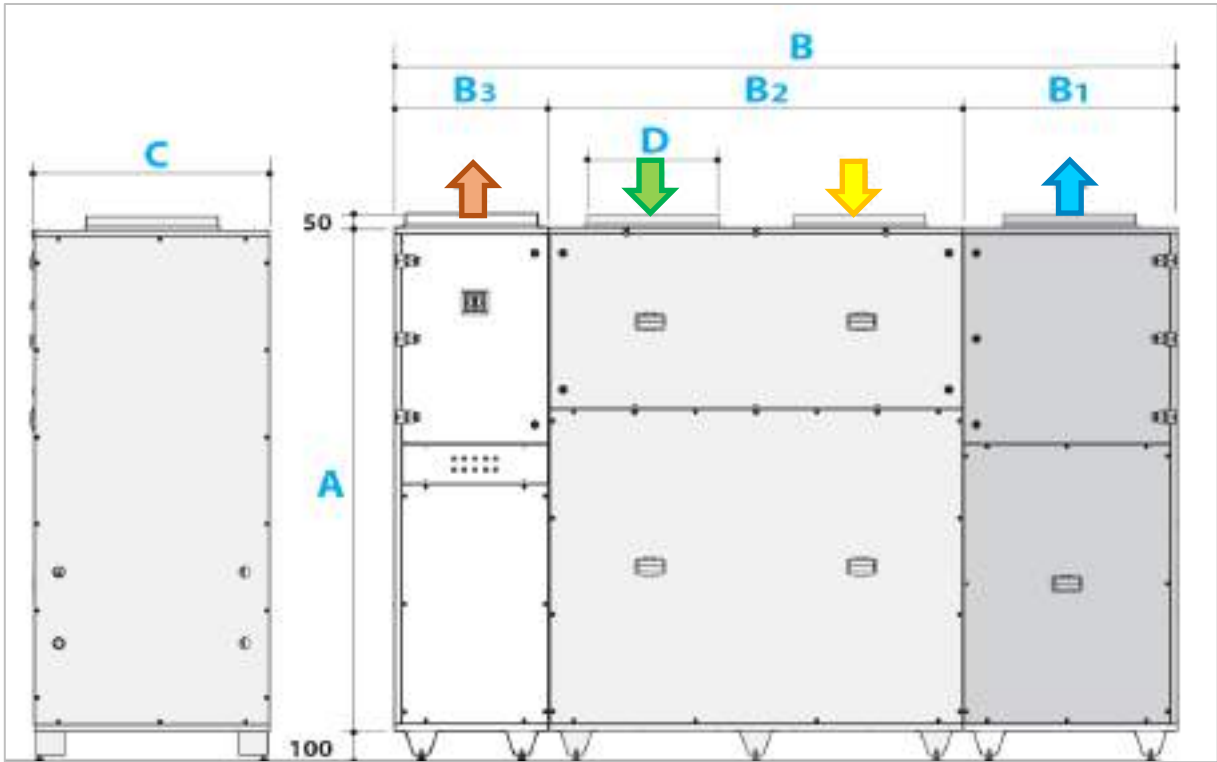

Size 06 & 07 – Right configuration

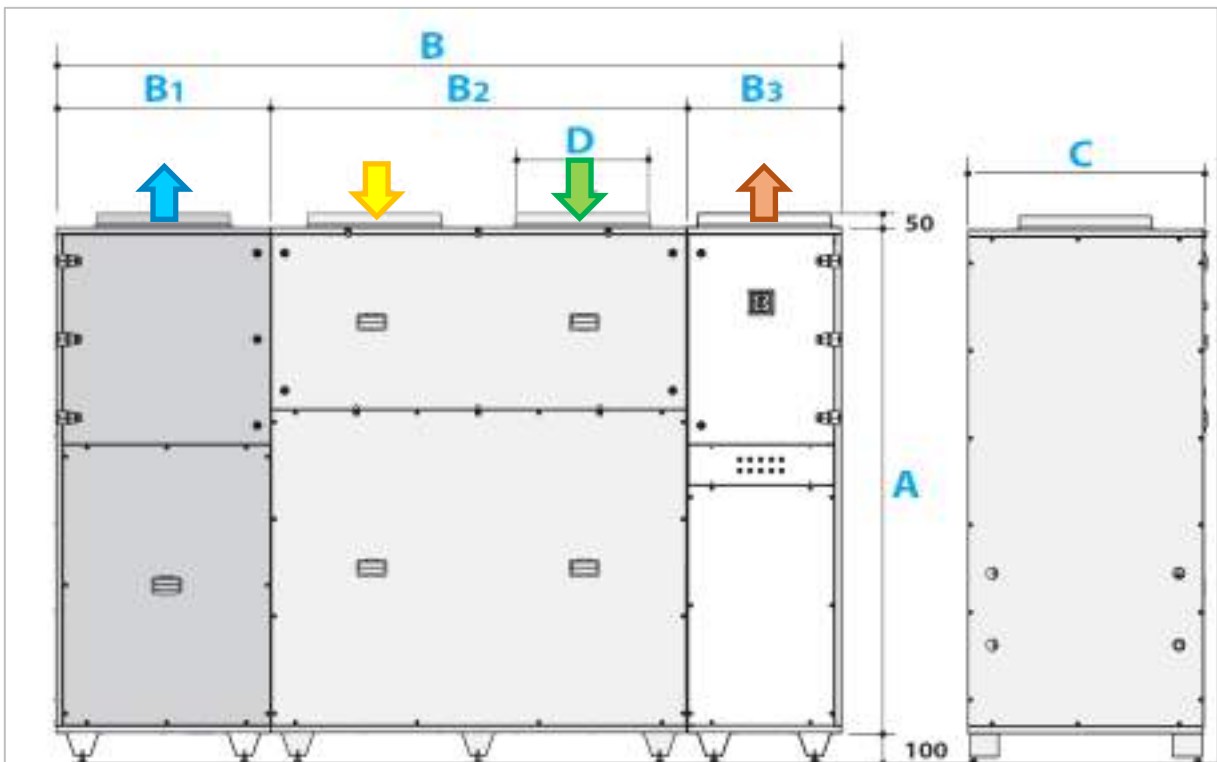

Size 06 & 07 – Left configuration

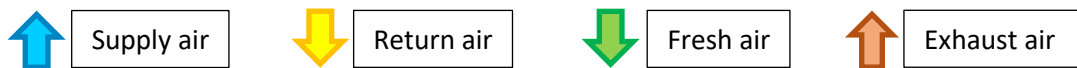

4.1.3. Nominal Air Flow

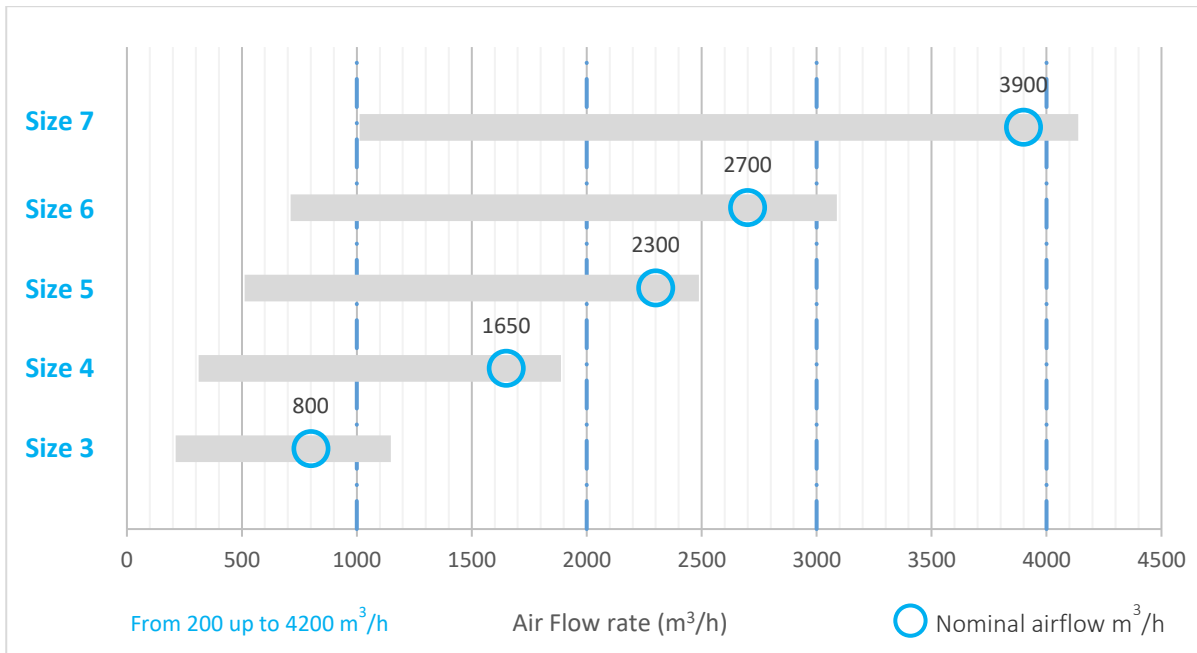

For any performances out of the nominal condition here above mentioned kindly refer to the online selection software available online at tools.daikinapplied.eu

4.2. Electrical Data

Material Name			ATB03*A*	ATB04*A*	SB.ATB05*A*	SB.ATB06*A*	SB.ATB07*A*
Size			03	04	05	06	07
Power Supply	Phase	-	1				
	Frequency	Hz	50-60				
	Voltage	V	220-240				
Full load condition	FLA	A	1.7	3.4	4.6	5.2	7.9
	FLI	W	390	780	1060	1190	1820

4.3. Declaration EU. REG. 1253/2014

Material Name			ATB03*A*	ATB04*A*	SB.ATB05*A*	SB.ATB06*A*	SB.ATB07*A*
Size			3	4	5	6	7
Manufacturer's name			Daikin Applied Europe				
Typology (NRVU, UVU / BVU) *			NRVU BVU				
Type of drive			Inverter (included on the electronic fan)				
Type of HRS			Other				
Thermal efficiency of the HR		%	76.8	75.7	73.4	76.7	78.2
Nominal NVRU Flow rate	Supply	m ³ /s	0.22	0.46	0.64	0.75	1.08
	Return	m ³ /s	0.22	0.46	0.64	0.75	1.08
Effective Electric Power input		kW	0.39	0.78	1.06	1.19	1.81
SFP internal	W/(m ³ /s)		756	846	799	756	866
Face velocity at design air flow rate	Supply	m/s	1.29	1.71	1.75	1.68	1.87
	Return	m/s	1.29	1.71	1.75	1.68	1.87
Internal Pressure Drop of Ventilation Components	Supply	Pa	188	265	261	246	276
	Return	Pa	193	274	270	255	286
Nominal External Pressure Drop	Supply	Pa	100				
	Return	Pa	100				
Static efficiency of fans	Supply	%	51	65	68	68	68
	Return	%	51	65	68	68	68
Maximum external Leakage	+ 400	%	3	3	3	3	3
	- 400	%	2	2	2	2	2
Maximum internal Leakage		%	2.5	2.5	2.5	2.5	2.5
Summer Outdoor Conditions	Temp.	°C	34				
	RH	%	50				
Winter Outdoor Conditions	Temp.	°C	-5				
	RH	%	90				
Filter Energy Classification			-				
Filter Service Warning **			Displayed on controller				
Sound Power Level		dBA	57	53	55	55	58
Pre-/Dis- assembly instructions			https://www.daikinapplied.eu/ahu-instructions-for-pre-disassembly/				

* In accordance with Commission Regulation (EU) No 1253/2014 of July 2014

** Clean/replace Filter(s) when maximum pressure drop is reached or when warning is displayed on HMI controller

4.4. Bearing structure

The units feature double-skin panels that consist of two folded steel sheets. Panel thickness is 50 mm for all unit sides. The standard versions provide Aluzinc AZ185 for the inner skin and pre-coated steel for the outer skin. The units are constructed with removable or hinged doors allowing full maintenance access. The units are equipped with circular flanges with gasket sealing to be connected to a circular ductwork on top.

4.5. Insulation

Insulation material used is mineral wool with a density of 120 kg/m³ (EN 1602).

Thermal conductivity is 0.036 W/m*K and mineral wool is A1 class for fire classification (EN13501-1).

4.6. Heat Exchanger

The units feature a counterflow plate heat exchanger (PHE). The PHE is able to recover up to 93% of thermal energy in wet conditions.

They are made of aluminium alloy with a minimum content of iron and copper (to avoid corrosion issues).

PHE is Eurovent certified and protected by minimum ePM₁₀ 80% (M5) & ePM₁ 50% (F7) grade pleated filters on extract and supply air sides. PHE incorporates an automatic bypass with two counterrotating dampers with actuator and a condensation drain pan with opportune slope.

4.7. Fans

4.7.1. Pro Version

The units comply with ErP 2018 rated and have IP54 EC fan/motor assemblies. EC fans are of IE5 efficiency class. Fans provide low specific fan power (SFP) and a stepless speed control.

According to their energy balance, performances, flow and noise characteristics the rotor shall be made by plastic (reinforced if necessary). The airflow rate shall be measured on the fan arrangement in real time.

Fans can provide a constant air volume regardless filter clogging or duct/system pressure drops (within the fans operation limits).

They are also able to provide a fixed pressure value regardless the supplied air volume or the pressure drops' changes in the system, while keeping the airflow information coming from the fans.

In terms of power supply, the unit must operate on 220/240 V AC, 50/60 Hz single-phase main supply.

4.7.2. Smart Version

The units comply with ErP 2018 rated and have IP54 EC fan/motor assemblies.

EC fans are of IE5 efficiency class. Fans provide low specific fan power (SFP) and a stepless speed control.

According to their energy balance, performances, flow and noise characteristics the rotor shall be made by plastic (reinforced if necessary).

Fans can run at least at 2 speeds (to be selected among 45 different operating points).

In terms of power supply, the unit must operate on 220/240 V AC, 50/60 Hz single-phase main supply.

4.8. Filters

Filter types are plane (compact) made with fibreglass material.

All the filters - regardless of their type – are mounted in opportune rails equipped with a mechanical frame that maintains the filters in pressure a high sealing along the full perimeter.

The available filter grades are: ISO Coarse 55% (G4), ePM₁₀ 80% (M5), ePM₁ 50% (F7) and ePM₁ 80% (F9). They can be combined to meet any kind of requirement.

The units come standard with ePM₁₀ 80% (M5) and ePM₁ 50% (F7) filters respectively for extract and supply air side. In accordance with ISO 16890, the unit can reach SUP (supply air categories) 1 level from ODA (outdoor air categories) 3 level.

The recommended minimum efficiencies depending on ODA and SUP categories are summarised in the following table.

Outdoor Air Quality	Supply air class			
	SUP 1 (High)	SUP 2 (Medium)	SUP 3 (Moderate)	SUP 4 (Low)
ODA 1 (Pure Air)	ePM1 70%	ePM1 50%	ePM2.5 50%	ePM10 50%
ODA 2 (Dust)	ePM1 80%	ePM1 70%	ePM2.5 70%	ePM10 80%
ODA 3 (Very high concentration of dust)	ePM1 90%	ePM1 80%	ePM2.5 80%	ePM10 90%

The recommended filter combination depending on ODA and SUP categories are summarised in the following table.

Outdoor Air Quality	Supply air class			
	SUP 1 (High)	SUP 2 (Medium)	SUP 3 (Moderate)	SUP 4 (Low)
ODA 1 (Pure Air)	F9	F7	F7	F7
ODA 2 (Dust)	F9	F9	F9	F7
ODA 3 (Very high concentration of dust)	F7 + F9	F9	F9	F9

For easy reference, the EN779:2012 has been replaced by the ISO 16890. The new naming is included in the following table.

Filter name (EN 779)	Filter name (ISO 16890)	ePM ₁	ePM _{2,5}	ePM ₁₀
G4	ISO Coarse 55%	N/A		
M5	ePM ₁₀ 75%	40%	50%	75%
F7	ePM ₁ 50%	50%	60%	80%
F9	ePM ₁ 80%	80%	85%	90%

The units, in fact, can accommodate on supply air stream up to three filters at the same time (M5+F7+F9). In order to avoid the fast clogging of the fine filter from gross particles, units can also provide a class G4 pre – filter on supply side.

According to the hygienic requirements of the VDI 6022, filter frames are designed in such a way so they can be easily extracted and cleaned.

The filter replacement is carried out from the front side opening the removable or hinged door.

The filters replacement trigger is activated through pressure differential transducers, following the provision of EU 1253/2014. Replacement filters are available as a standard accessory.

4.9. Control system

4.9.1. Pro Controls

Unit control system is provided on the basis of a programmable direct digital controller (DDC). Its software allows user configuration setting based on original manufacturer logics.

The unit controls are factory mounted and fully operational at site.

A web server (HMI) is also provided as a standard feature.

The unit offers the possibility to be integrated into BACnet/IP or Modbus-RS485 based BMS through dedicated accessories. The unit is connectable to a Cloud monitoring system (optional).

The unit is able to operate either in CAV or VAV systems. For the constant air volume (CAV) logic the unit provides a constant airflow regardless of system pressure drops. For the variable air volume (VAV) logic the unit guarantees a constant static pressure in a specific point of the system, through dedicated accessory (Digital PCB for external accessories: ATE00PDUA), while the airflow measurement remains available for reading.

The unit is able to control the indoor air quality by controlling and monitoring the CO₂ level (CO₂ sensor is optional). In fact, when the threshold value is overcome, the control forces the fan to increase the extracted and supplied air volume in order to decrease the CO₂ level faster.

When signals are received, the units vary its fan speed proportionally until the desired set points are met.

An optional humidity sensor is available for the control of the humidity condition when a cooling coil is present. If temperature control is also needed, a post heating coil has to be present too.

The automatic operation of the bypass, instead, is determined by an algorithm that varies output based on temperature evaluations. Bypass control provides free cooling operation based on dry bulb temperatures and enthalpies (optional) through additional humidity probes (accessories). Defrost operation together with a modulating internal water heating coil (if available) is also possible, in order to give the best solution in terms of energy efficiency and cost reduction.

Units fit four temperature probes to measure: Supply air temperature, Return Air temperature, Fresh air and Exhaust Air Temperature.

Modular T Control	
Control platform	Programmable controller
Remote controller	Room controller: ALC00822A
	Commissioning tool: ALC00895A
Co2 control	Yes, ALP00COA (mandatory accessory)
RH% control	Yes, ALP00HUA (mandatory accessory)
BMS Connectivity	BACnet/IP: ALC00908A (accessory)
	Modbus – RS485: ALC00902A (accessory)
Ethernet connection	WEB – Human Machine Interface (web server)
Cloud connection	Daikin on Site

4.9.2. Smart Controls

Modular T Smart can be directly integrated into DIII-net ecosystem and controlled through any Daikin local, centralised controllers (iTAB, iTM, iTC) or Cloud controllers (Daikin Cloud Service).

This communication, based on the common F1-F2 and P1-P2 protocol, guarantees also fully compatibility with SkyAir and VRV systems.

The remote controller BRC1[E/H] is not provided with the main module and has to be provided separately. Modular T Smart comes standard with 2 sensors fitted on the fresh and return air side.

The temperature control done by the unit is to compare outside temperature with inside temperature, to decide whether to operate in “heat exchange” or in “bypass mode” in case the user selects “auto mode” (please refer to the table below).

Mode	Description
Auto mode	Using information from the air conditioner (cooling, heating, fan and set temperature) and heat reclaim ventilation unit (indoor and outdoor temperatures), this mode automatically changes between Energy Reclaim Ventilation and Bypass mode
Energy Reclaim Ventilation mode	The outdoor air is supplied to the room after passing through a heat exchanger element, where heat is exchanged with the return air
Bypass mode	The outdoor air bypasses the heat exchanger element. This means that outdoor air is supplied to the room without exchanging heat with the return air

The unit is connectable to a Cloud monitoring system (optional).

BACnet or Modbus integration is possible through interfaces (optional).

The unit is able to control the indoor air quality by controlling and monitoring the CO2 level (CO2 sensor is optional).

Modular T Control	
Control platform	Daikin Control PCB
Remote controller	Room controller: Optional BRC 1 [E/H]
Co2 control	Optional, BRYMA2000 sensor
BACnet or Modbus integration	Through interfaces (optional)
Cloud connection	Daikin Cloud Service

4.10. Default Values

4.10.1. Pro Version

All the unit are pre factory set at nominal value summarize in the table below. All the values can be changed using the Commissioning Module (ALC00895A).

Modular T	Material Name	ATB03*A	ATB04*A	ATB05*A	ATB06*A	ATB07*A
Constant air volume (CAV) ¹	Auto (m ³ /h)	800	1650	2300	2700	3900
	Eco (m ³ /h)	400	825	1150	1300	1950
Variable air volume (VAV) ²	Auto (Pa)	100	100	100	100	100
	Eco (Pa)	50	50	50	50	50
Supply air Temperature	Winter	22 °C				
	Summer	22 °C				
CO ² Control ³	Trigger value (PPM)	1000	1000	1000	1000	1000
	Max forcing %	25% of the maximum fan speed				
Schedule ¹	Time	08:00 – 18:00				
	Day	Monday – Friday				
Filter Replacement ⁴	M5 (Pa)	250				
	F7 (Pa)	250				

1. Pre-set values (Default)
2. Values fixed but not enabled (VAV kit required)
3. Values fixed but not enabled (ALP00COA CO2 probe accessory mandatory)
4. Trigger value for filters' replacement. In case of non – standard filters, the installer needs to change manually the differential pressure value in accordance with the filter class. The recommended values are mentioned in the filter accessory section.

4.10.2 Smart version

Factory set values for nominal operating airflow and corresponding setting for the BRC1[E/H].
Please refer to the IOM, in order to determine new operating points and new unit setting for various speeds.

Size 03			
Supply		Exhaust	
Volume Flow rate	ESP	Volume Flow rate	ESP
800	100	800	100
RPM		RPM	
2310		2276	
Fan speed (High – Ultra High)			
17(27)-4-01			
Fan Curve Supply		Fan Curve Return	
19(29)-2-09		19(29)-3-05	

Size 04			
Supply		Exhaust	
Volume Flow rate	ESP	Volume Flow rate	ESP
1650	100	1650	100
RPM		RPM	
2835		2873	
Fan speed (High – Ultra High)			
17(27)-4-02			
Fan Curve Supply		Fan Curve Return	
19(29)-2-09		19(29)-3-10	

Size 05			
Supply		Exhaust	
Volume Flow rate	ESP	Volume Flow rate	ESP
2300	100	2300	100
RPM		RPM	
2743		2692	
Fan speed (High – Ultra High)			
17(27)-4-02			
Fan Curve Supply		Fan Curve Return	
19(29)-2-11		19(29)-3-08	

Size 06			
Supply		Exhaust	
Volume Flow rate	ESP	Volume Flow rate	ESP
2700	100	2700	100
RPM		RPM	
2280		2284	
Fan speed (High – Ultra High)			
17(27)-4-02			
Fan Curve Supply		Fan Curve Return	
19(29)-2-12		19(29)-3-10	

Size 07			
Supply		Exhaust	
Volume Flow rate	ESP	Volume Flow rate	ESP
3900	100	3900	100
RPM		RPM	
2143		2155	
Fan speed (High – Ultra High)			
17(27)-4-02			
Fan Curve Supply		Fan Curve Return	
19(29)-2-10		19(29)-3-08	

4.11. Antifreeze Logic

4.11.1. Pro Version

This function is used to avoid plate heat exchanger freezing as it activates a sequence of actions to counteract the risk of frost formation.

The antifreeze logic is activated whenever outdoor and exhaust temperatures fall below pre-set values and pressure drop across the heat exchanger, monitored thanks to a pressure transducer, exceeds a pre-set threshold for a specific time duration. Once the logic is active, the actions performed are the following:

Antifreeze disabled	No action
Antifreeze enabled	1) Bypass damper is gradually open up to 100% (only if heating coil present)
	2) Supply airflow is gradually reduced and return airflow is gradually increased up to a 20% variation
	3) Pre-heating coil is activated (if present)
	4) Unit goes in alarm if the last action performed is not effective to exit freeze condition in less than 30 min. An auto-reset is performed after 1 hour, after which the unit starts again automatically.

4.11.2. Smart Version

In accordance with the image here below showed, adding a pre-electrical heater (ATD**HEFBU) is mandatory for outdoor temperature lower than -5°C for either tackling or preventing frost issue.

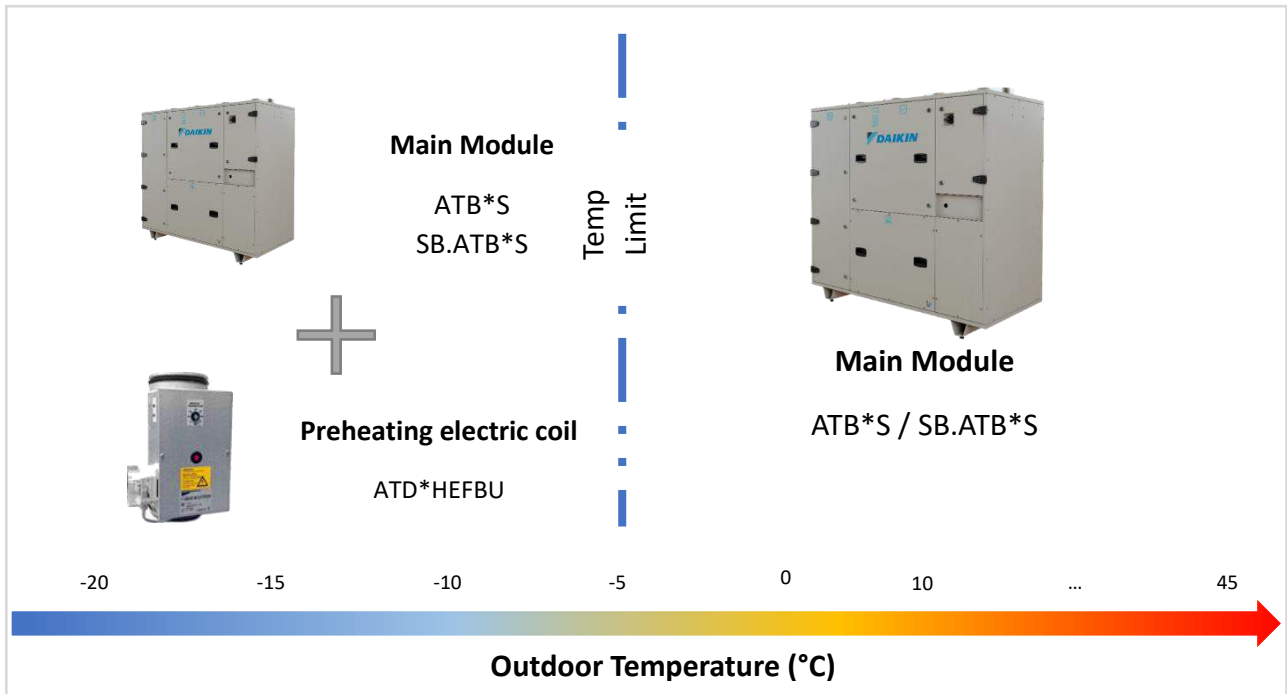

The unit has been equipped with a differential pressure switch to prevent a possible risk of icing at heat exchanger level. Depending on the working condition, the installer must adjust the setting according the charts below.

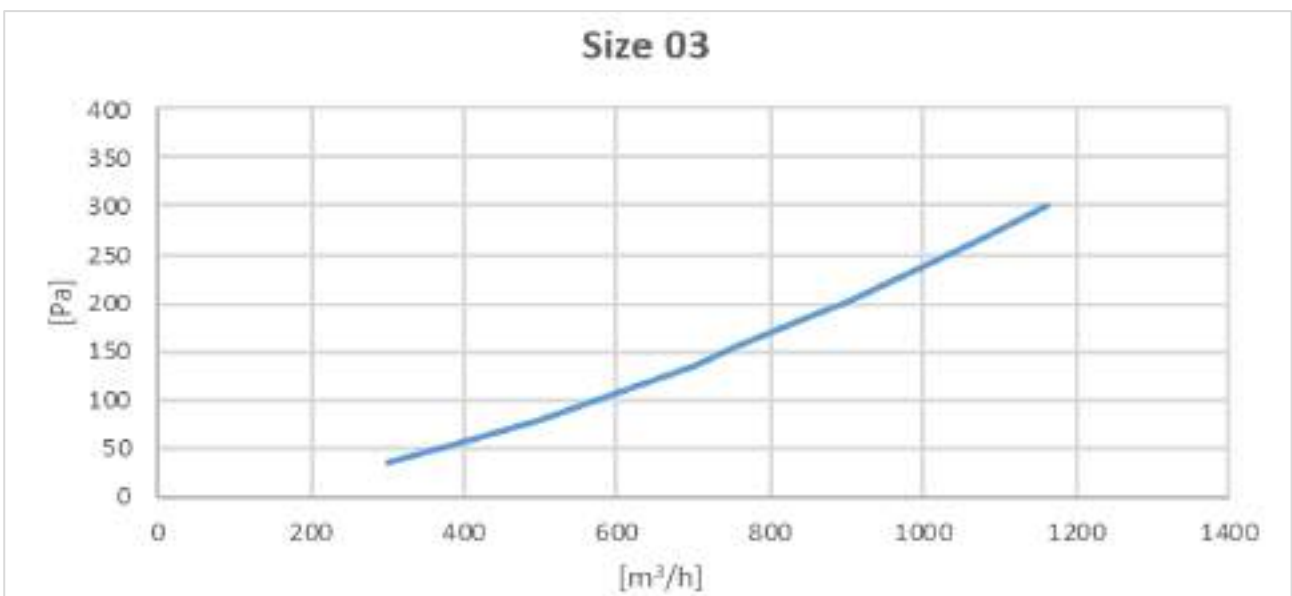

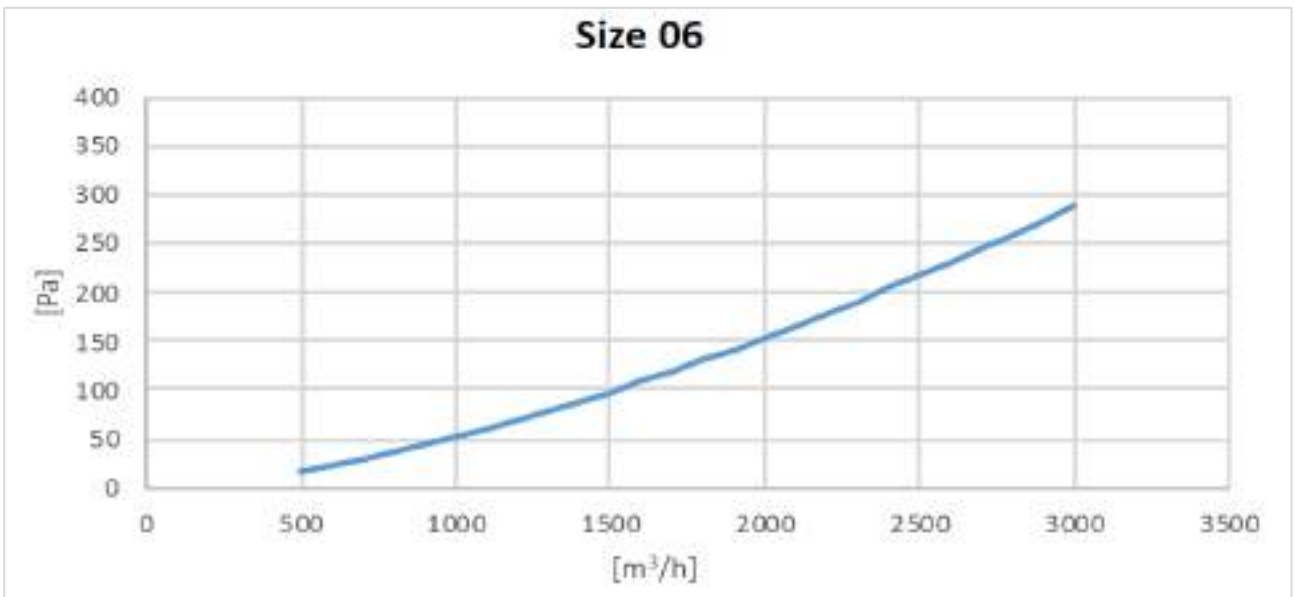
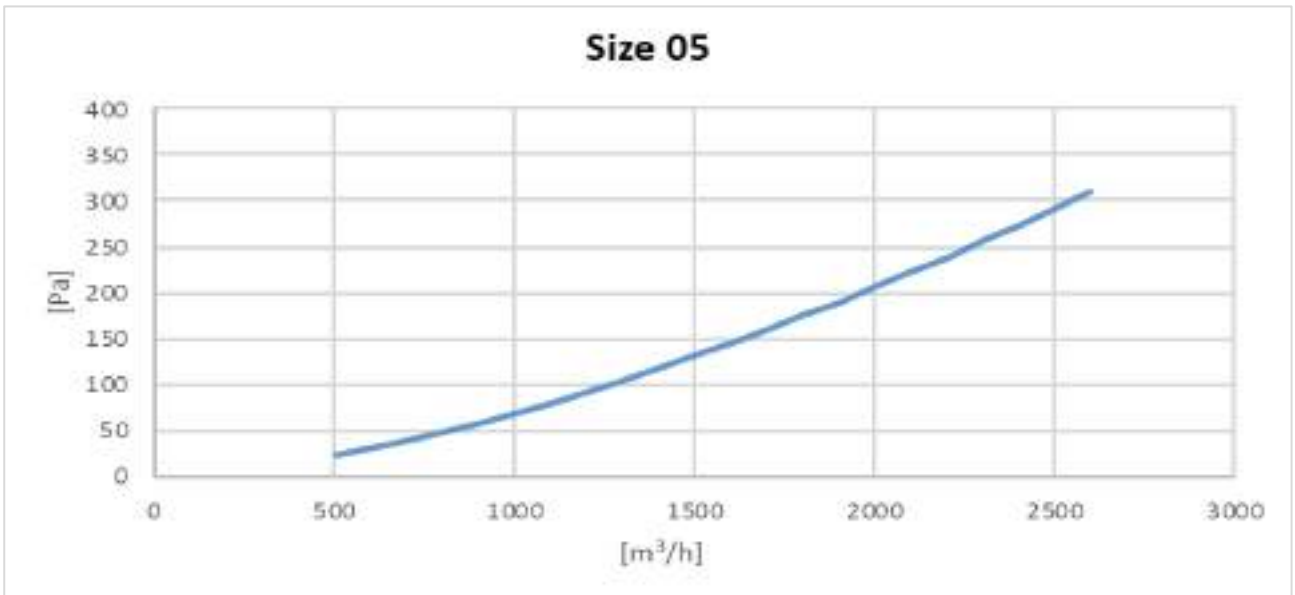
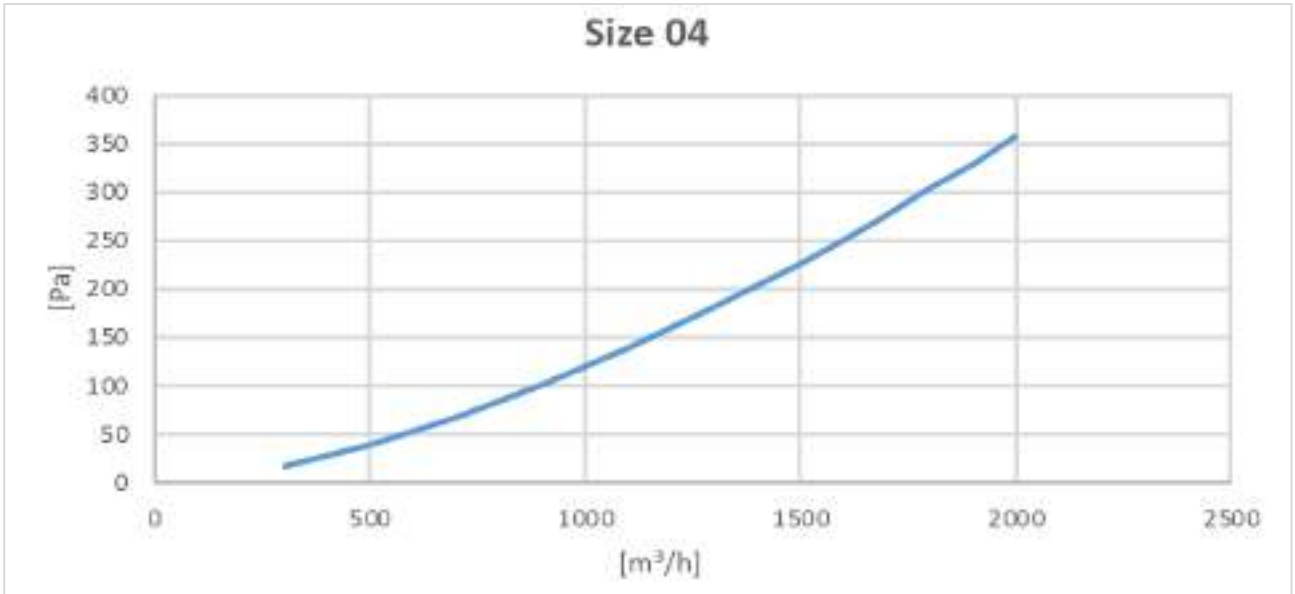

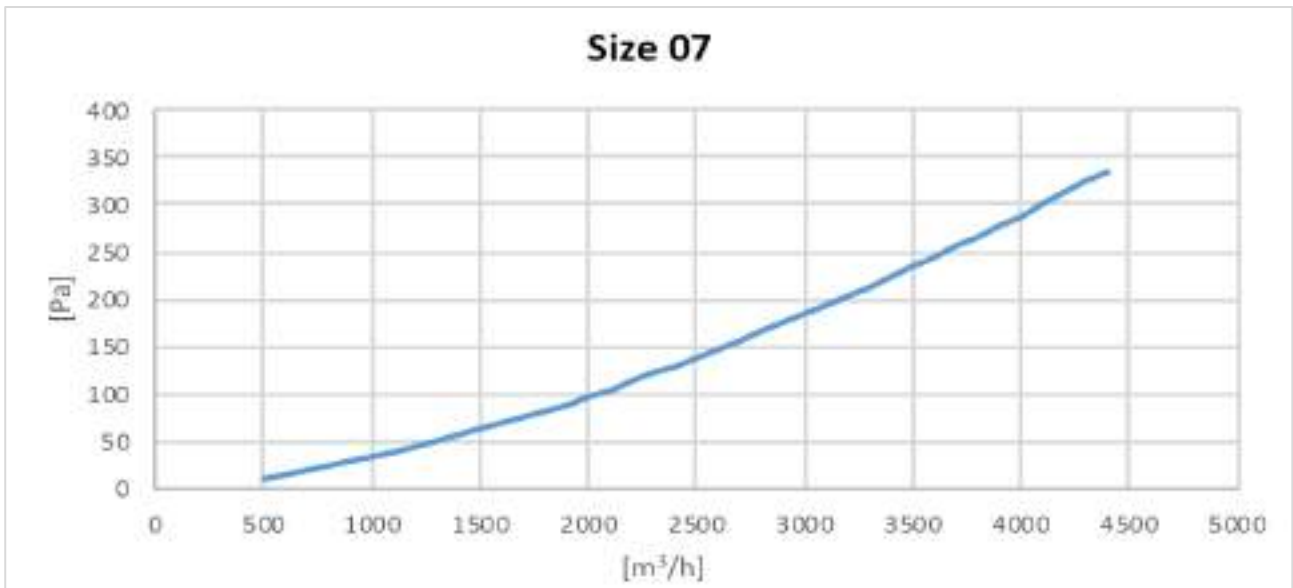

Please refer to the Installation and Operation Manual (IOM) for further information.

4.12. Operating Limits

Modular T heat recovery units are designed for use in indoor environments, installed on the floor. The unit cannot operate in environments containing explosive material and with a high concentration of dust. Thanks to its modularity, each machine is able to adapt to different needs in terms of air flow and thermodynamic treatments. The optimised choice of every detail, the search for maximum efficiency in each component, the adoption of specific materials and constructive solutions transform environment friendliness and energy savings into valid and advanced technological solutions.

4.12.1. Pro Version

	Configuration	Size	Lower limit temperature (°C)	Upper limit temperature (°C)
Outside air temperature	without coil	All	-10°C	46°C
	with pre heating coil	All	-25°C	46°C
Operating environment temperature	All	All	-5°C	46°C
Temperature of environment with the machine off (e.g., storage, transport, etc.)	All	All	-40°C	60°C

4.12.2. Smart Version

	Configuration	Size	Lower limit temperature (°C)	Upper limit temperature (°C)
Outside air temperature	without coil	All	-5°C	46°C
	with pre heating coil	All	-25°C	46°C
Operating environment temperature	All	All	5°C	46°C
Temperature of environment with the machine off (e.g., storage, transport, etc.)	All	All	-40°C	60°C

5. Accessories

5.1. Accessories list

		Size				
Accessories	Version	03	04	05	06	07
<u>Compact Filter</u>						
ISO Coarse 55% (G4)	Smart & Pro	ATF03G4A	ATF04G4A	ATF05G4A	ATF06G4A	ATF07G4A
ePM10 75% (M5)	Smart & Pro	ATF03M5A	ATF04M5A	ATF05M5A	ATF06M5A	ATF07M5A
ePM1 50% (F7)	Smart & Pro	ATF03F7A	ATF04F7A	ATF05F7A	ATF06F7A	ATF07F7A
ePM1 80% (F9)	Smart & Pro	ATF03F9A	ATF04F9A	ATF05F9A	ATF06F9A	ATF07F9A
<u>Coil Module</u>						
DX Right	Pro	ATD03UDSAR	ATD04UDSAR	ATD05UDSAR	ATD06UDSAR	ATD07UDSAR
DX Left	Pro	ATD03UDSAL	ATD04UDSAL	ATD05UDSAL	ATD06UDSAL	ATD07UDSAL
Water Right	Pro	ATD03UWSAR	ATD04UWSAR	ATD05UWSAR	ATD06UWSAR	ATD07UWSAR
Water Left	Pro	ATD03UWSAL	ATD04UWSAL	ATD05UWSAL	ATD06UWSAL	ATD07UWSAL
Electric Preheating	Pro	ATD03HEFAU	ATD04HEFAU	ATD05HEFAU	ATD06HEFAU	ATD07HEFAU
Electric Preheating	Smart	ATD03HEFBU	ATD04HEFBU	ATD05HEFBU	ATD06HEFBU	ATD07HEFBU
Water Preheating	Pro	ATD03HWFAU	ATD04HWFAU	ATD05HWFAU	ATD06HWFAU	ATD07HWFAU
Water post heating R	Pro	ATD03HWSAR	ATD04HWSAR	ATD05HWSAR	ATD06HWSAR	ATD07HWSAR
Water post heating L	Pro	ATD03HWSAL	ATD04HWSAL	ATD05HWSAL	ATD06HWSAL	ATD07HWSAL
Electric post heating	Pro	ATD03HESAU	ATD04HESAU	ATD05HESAU	ATD06HESAU	ATD07HESAU
<u>Valves</u>						
2-way water cooling	Pro	ATV03CW2A	ATV04CW2A	ATV05CW2A	ATV06CW2A	ATV07CW2A
3-way water cooling	Pro	ATV03CW3A	ATV04CW3A	ATV05CW3A	ATV06CW3A	ATV07CW3A
2-way water heating	Pro	ATV03HW2A	ATV04HW2A	ATV05HW2A	ATV06HW2A	ATV07HW2A
3-way water heating	Pro	ATV03HW3A	ATV04HW3A	ATV05HW3A	ATV06HW3A	ATV07HW3A

<u>Mechanical Accessories</u>						
Silencers	Smart & Pro	ATA0360A	ATA0460A	ATA0560A	ATA0660A	ATA0760A
Mixing Damper	Pro	ATA03MDA	ATA04MDA	ATA05MDA	ATA06MDA	ATA07MDA
External Damper	Pro	ATA03EDA	ATA04EDA	ATA05EDA	ATA06EDA	ATA07EDA
<u>Control</u>						
Module Bacnet Interface	Pro	ALC00908A				
Module Modbus Interface	Pro	ALC00902A				
Room Thermostat	Pro	ALC00822A				
Commissioning Module	Pro	ALC00895A				
<u>Electrical accessories</u>						
Frost Switch	Pro	ATE00FSUA				
Modulating actuator for valves	Pro	ATE00AMVA				
Modulating actuator for dampers	Pro	ATE00AMDA				
Digital PCB for external accessories	Pro	ATE00DPUA				
<u>Probes</u>						
Temperature	Pro	ALP00TEA				
Humidity (%RH)	Pro	ALP00HUA				
CO ₂	Pro	ALP00COA				

5.2. Accessories for Pro & Smart version

5.2.1. Filters

The unit is provided as standard with ePM1 50% (F7) filter on supply side and ePM1 75% (M5) filter on return. On supply side up to three filtration stages as available. It is not possible to install the third filtration stage and the water post heating coil at the same time. Other filters available are ePM1 80% (F9) filter and ISO Coarse 55% (G4). The table below summarizes the material names and the pressure drop for each filter, when it is clean, at nominal air flow for all the sizes.

Material Name	Main Unit Size	Description	ΔP Clean (Pa)	ΔP Mean (Pa)
ATF03G4A	03	ISO Coarse 55% (G4)	61	101
ATF04G4A	04		82	132
ATF05G4A	05		80	130
ATF06G4A	06		78	128
ATF07G4A	07		85	135
ATF03M5A	03	ePM10 75% (M5)	81	131
ATF04M5A	04		108	158
ATF05M5A	05		105	155
ATF06M5A	06		103	153
ATF07M5A	07		111	161
ATF03F7A	03	ePM1 50% (F7)	94	144
ATF04F7A	04		125	175
ATF05F7A	05		122	172
ATF06F7A	06		119	169
ATF07F7A	07		129	179
ATF03F9A	03	ePM1 80% (F9)	148	198
ATF04F9A	04		198	248
ATF05F9A	05		193	243
ATF06F9A	06		188	238
ATF07F9A	07		204	254

The pressure drop is referring to nominal airflow.

5.2.2. Silencers

Silencers for supply and or return ducts are available for each size. The length of silencer is 600mm. They are circular, in this way no duct transitions are needed. In the next table, there are attenuation data for each frequency:

Material Name	Size	Diameter (mm)	Frequency [Hz]								Avg dB(A)
			63	125	250	500	1000	2000	4000	8000	
ATS0360A	03	250	-	2	8	14	25	12	6	7	25
ATS0460A	04	315	-	2	6	12	14	9	5	5	17
ATS0560A	05	355	-	2	6	7	12	6	3	4	14
ATS0660A	06	400	-	2	4	5	10	4	3	2	12
ATS0760A	07	500	-	1	1	4	2	1	1	1	8

5.3. Accessories only for Pro version

5.3.1. Useful information

- Both pre ATD**HEFA and post ATD**HESA electric heaters must be equipped with an additional temperature probe (ALP00TEA) fitted in the duct and wired to the dedicated terminals.
- Each size can be equipped with two different electric heaters: ATD0*HESAU (low capacity) or ATD0*HEFAU (high capacity). Both of them can be installed as pre and post heating coil. Only difference between the two coil is the maximum reachable power. Astra Web selection software, based on specific project's conditions, will automatically select the most suitable coil.
- Post heating (ATD**HWFAU / ATD**HWSA*) and main water coil (ATD**UWSA*) do not require additional temperature probes. In addition, either a 2- or 3-ways regulating valves (ATV**HW2A, ATV**HW3A, ATV**CW2A, ATV**CW3A) can be ordered along with modulating actuators for water valve (mandatory option ATE00AMVA), supplied loose for site fitting.
- On Astra Web selection software for Modular T Pro version, the temperature probe is automatically added (if needed) when a coil is selected.
- On Astra Web selection software for Modular T Pro version, the modulating actuators is automatically added when a water valve is selected.
- The accessory compatibility might be limited on the basis of the control features and/or for the position of the accessories. Kindly refer to your sales representative in case of doubts. Main incompatibilities are summarised below:
 - DX coil and main Water Coil
 - Electric pre heating and water pre heating
 - Electric post heating and water post heating
 - Third filtration stage and water post heating

- For Modbus (ALC00902A) and BACnet (ALC00908A) modules selection there is no exclusion
- Room thermostat (ALC00822A) is supplied with the main unit (ATB0**A) as a standard item
- Commissioning module (ALC00895A) is required for purpose of either airflow volumes or static pressure value changes from the ones set at factory.
- The unit gets delivered with its nominal air flow rate set up at factory. To adjust its operation to the project-specific parameters, kindly select the optional commissioning module ALC00895A or refer to Daikin Service Dept. Alternatively, you can also commission the units using the web server HMI access (default feature)
- When a mixing and/or an external Damper is selected Astra will automatically add the modulating actuator.

5.3.2. Coils

Modular T pro version can be equipped with different types of coils, all provided as accessory, to guarantee the thermal comfort.

An electric heater or water heating coil are available as accessories as preheating coil.

To manage the thermal load in both winter and summer seasons, a DX or water-based coils are available as main coil option. Both must be installed inside the unit along with their drip tray. Please refer to the installation manual for further information on the installation.

DX and water coils are provided in left and right version based on unit version chosen. It is not possible to install a right (left) coil version if a left (right) unit has been selected and vice-versa.

A water coil, installed inside the unit, and an electric heater, installed in the ductwork, are available as post heating options. Like DX and water main coils, also the post heating water coil is available with right and left versions.

Modular T can be equipped with up to three coils (pre, main and post) and all of them work on modulating way at the same time.

Astra Web selection software automatically adds a temperature probe (ALP00TEA) whenever needed.

For each size, users can select two different electric heating coils. Both can be mounted on fresh and supply side depending on specific project requirements.

The additional Digital PCB for external accessories (option: ATE00DPUA), is mandatory when a coil, mounted externally of the main unit, is selected. The coils mounted externally of the main unit are:

- Pre and post electric coil
- Pre heating water coil

5.3.2.1. Water coil

A cooling and heating water coil is available as accessory to guarantee the thermal treatment. In addition, either a 2- or 3-way valves (ATV**HW2A, ATV**HW3A, ATV**CW2A, ATV**CW3A) must be ordered along with modulating actuators (ATE00AMVA). Astra Web selection software will automatically add the actuator whenever the valve option is selected.

The water coil must be installed inside the unit along with its drip collection tray. Please follow the dedicated IOM for further information on the installation procedure. Water coil is provided in left and right version based on unit version chosen. It is not possible to install a right (left) coil version if a left (right) unit has been selected. In the following table, main technical info of the water coil for Modular T are summarized.

Material Name	ATD03UWSAL ATD03UWSAR	ATD04UWSAL ATD04UWSAR	ATD05UWSAL ATD05UWSAR	ATD06UWSAL ATD06UWSAR	ATD07UWSAL ATD07UWSAR
Size	03	04	05	06	07
Description	Water Coil Left (ATD0*UWSAL) and Right (ATD0*UWSAR) version				
Lenght (mm)	480	730	685	685	785
Depth (mm)	160	160	160	160	160
Height (mm)	440	410	640	730	850
Weight ¹ (kg)	10	15	21	23	30
Fluid Volume (dm ³)	2,7	3,9	6,8	8,3	11
Connection	¾'	¾'	1'	1 ¼'	1 ¼'

1. Empty weight

5.3.2.2. DX Coil

A cooling and heating DX coil is available as accessory to guarantee the thermal treatment. In the Astra Web report, the Daikin Electronic Valve Kit (EKEXV*) model which has to be site installed, is specified.

The DX coil must be installed inside the unit along with its drip collection tray. Please follow the dedicated IOM for further information on the installation procedure. DX coil is provided in left and right version based on unit version chosen. It is not possible to install a right (left) coil version if a left (right) unit has been selected.

In the following table, main technical info of the DX coil for Modular T are summarized.

Material Name	ATD03UDSAL ATD03UDSAR	ATD04UDSAL ATD04UDSAR	ATD05UDSAL ATD05UDSAR	ATD06UDSAL ATD06UDSAR	ATD07UDSAL ATD07UDSAR
Size	03	04	05	06	07
Description	DX Coil Left (ATD0*UDSAL) and Right (ATD0*UDSAR) version				
Lenght (mm)	485	725	695	695	795
Depth (mm)	135	135	135	135	135
Height (mm)	400	400	650	725	850
Weight ¹ (kg)	7	10	14	15	21
Fluid Volume (dm ³)	1,57	2,5	4,04	4,54	6,26
Recommended Electronic expansion Valve ¹	EKEXV63	EKEXV80	EKEXV125	EKEXV140	EKEXV200
		EKEXV100	EKEXV140	EKEXV200	EKEXV250
Manifolds (mm)	1 x 16	1 x 16	1 x 16	1 x 16	1 x 16
Distributors (mm)	1 x 12	1 x 16	1 x 22	1 x 22	1 x 28

1. Not supplied

5.3.2.3. Electrical pre and post heating coil

For each size, two electrical heaters are available for selection, with the following material name and features:

Size	Material Name	Max Power Output (Kw)	Electric Data	Diameter / Depth (mm)	Length (mm)	Height (mm)	Weight (kg)
03	ATD03HEFAU	12	400/3/50	250	325	500	9
	ATD03HESAU	4.5	400/3/50		325	370	6
04	ATD04HEFAU	15	400/3/50	315	390	630	15
	ATD04HESAU	6	400/3/50		390	375	8
05	ATD05HEFAU	18	400/3/50	355	425	630	17
	ATD05HESAU	6	400/3/50		425	375	9
06	ATD06HEFAU	21	400/3/50	400	485	770	22
	ATD06HESAU	7.2	400/3/50		485	375	10
07	ATD07HEFAU	24	400/3/50	500	585	785	29
	ATD07HESAU	8.4	400/3/50		585	375	15

The difference between the two coils, is the power output that can be achieved. This means both can be mounted as pre heating and post heating, depending on the specific project requirement. The additional PCB for external accessories (ATE00DPUA) is required in order to enable communication between controller and external heaters. In the Astra Web selection software for Modular T Pro version, the additional temperature probe and optional PCB for accessories are automatically added when an electric heater is selected.

5.3.2.4. Water pre-heating coil

A heating coil is available as accessory as pre heating. The coil is mounted outside the main module and it must be ducted. Following table summarizes main technical data for pre heating water coil.

Material Name	ATD03HWFAU	ATD04HWFAU	ATD05HWFAU	ATD06HWFAU	ATD07HWFAU
Size	03	04	05	06	07
Description	Pre heating Water Coil (ATD0*HWFAU)				
Lenght (mm)	345	420	445	495	595
Depth (mm)	280	355	380	430	530
Height (mm)	280	280	280	280	280
Weight ¹ (kg)	25	32	35	40	53
Connection	½"	½"	½"	½"	¾"

In the Astra Web selection software for Modular T Pro version, the additional temperature probe (ALP00TEA) and optional PCB for accessories (ATE00DPUA) are automatically added when pre heating water coil is selected.

5.3.2.5. Water post-heating coil

A heating water coil is available as accessory as post heating. The coil is mounted outside the main module. Please follow the dedicated IOM for further information on the installation procedure.

Following table summarizes main technical data for post heating water coil.

Material Name	ATD03HWSAL ATD03HWSAR	ATD04HWSAL ATD04HWSAR	ATD05HWSAL ATD05HWSAR	ATD06HWSAL ATD06HWSAR	ATD07HWSAL ATD07HWSAR
Size	03	04	05	06	07
Description	Post heating Water Coil Left (ATD0*HWSAL) and Right (ATD0*HWSAR) version				
Lenght (mm)	480	730	685	685	785
Depth (mm)	100	100	130	130	130
Height (mm)	380	350	500	610	710
Weight ¹ (kg)	6	9	12	13	17
Fluid Volume (dm ³)	1,3	1,8	3	3,5	5,4
Connection	¾'	¾'	1'	1'	1 ¼'

5.3.3. Valves

The regulating valves are needed when a water coil is selected. For each size, four types of valves are available, cooling or heating, two or three ways. Main info for the valves is summarized in the table below:

Material Name	Size	Cooling/Heating	2 or 3 ways	DN	PN	KVs (m ³ /s)
ATV03CW2A	03	Cooling	2	15	40	2,5
ATV03CW3A	03	Cooling	3	15	40	2,5
ATV03HW2A	03	Heating	2	15	40	2,5
ATV03HW3A	03	Heating	3	15	40	2,5
ATV04CW2A	04	Cooling	2	15	40	4
ATV04CW3A	04	Cooling	3	15	40	4
ATV04HW2A	04	Heating	2	15	40	4
ATV04HW3A	04	Heating	3	15	40	4
ATV05CW2A	05	Cooling	2	20	40	6,3
ATV05CW3A	05	Cooling	3	20	40	6,3
ATV05HW2A	05	Heating	2	20	40	6,3
ATV05HW3A	05	Heating	3	20	40	6,3
ATV06CW2A	06	Cooling	2	20	40	8,6
ATV06CW3A	06	Cooling	3	20	40	10
ATV06HW2A	06	Heating	2	20	40	8,6
ATV06HW3A	06	Heating	3	20	40	10
ATV07CW2A	07	Cooling	2	25	40	10
ATV07CW3A	07	Cooling	3	25	40	10
ATV07HW2A	07	Heating	2	25	40	10
ATV07HW3A	07	Heating	3	25	40	10

5.3.4. Dampers

Two type of dampers are available as option for Modular T: mixing damper to allow recirculation and external dampers for AHU isolation.

5.3.4.1. Mixing Damper

A mixing Damper is available as accessory to allow recirculation of the air, saving energy and consequently decrease running cost of the unit. It also enables total space air conditioning. In the table below, the material names of the mixing damper for each size are shown:

Size	03	04	05	06	07
Material Name	ATA03MDA	ATA04MDA	ATA05MDA	ATA06MDA	ATA07MDA

In order to achieve the 100% of recirculated air, if required, two external dampers (on fresh and exhaust connections) must be installed. Astra web does not automatically add them, so these have to be manually selected whenever needed. The mixing damper requires the modulating actuator (ATE00AMDA).

5.3.4.2. External Dampers

External dampers can be installed on all the four air flow connections.

It is advised to install the external dampers on supply and return duct connection when a mixing damper is selected. The external dampers require the modulating actuator (ATE00AMDA). In the table below the material names for external dampers are summarized. Each material name accounts for two dampers.

Size	03	04	05	06	07
Material Name	ATA03EDA	ATA04EDA	ATA05EDA	ATA06EDA	ATA07EDA

5.3.5. Electrical accessories

5.3.5.1. Frost Switch

The frost switch (ATE00FSUA) protects the water coil from freezing. It is placed after the coil and when air temperature is below 5°C, the unit stops to operate. The frost switch auto resets if conditions allow a safe functioning of the AHU again.

5.3.5.2. Modulating actuator for valves

The modulating actuator (ATE00AMVA) is automatically added in Astra when a valve is selected.

Control Type	DC 2-10 V
Torque	5 Nm
Voltage AC/DC	AC/DC 24V
Degree of protection	IP54

5.3.5.4. Digital PCB for external accessories

For accessories mounted externally to the main unit, which require to be controlled, it is mandatory to add a further digital PCB (ATE00DPUA). The following components require

- Electric pre and post heating coils
- Water preheating coil

Digital PCB is also needed when additional filters are mounted and it is required to monitor pressure drop for each filtration stage, according to VDI6022.

5.4. Accessories only for Smart version

5.4.1. Coils

5.4.1.1. Electrical pre-heating coil

Only coil available for Smart version is pre heating electric coil. In the following table, main info is summarized:

Size	Material Name	Max Power Output (Kw)	Electric Data	Diameter / Depth (mm)	Length (mm)	Height (mm)	Weight (kg)
03	ATD03HEFBU	12	400/3/50	250	325	500	8
04	ATD04HEFBU	15	400/3/50	315	390	630	15
05	ATD05HEFBU	18	400/3/50	355	425	630	17
06	ATD06HEFBU	21	400/3/50	400	485	770	22
07	ATD07HEFBU	24	400/3/50	500	585	785	29

6. Performance

This section summarizes the main technical data for each size: envelope for each unit, thermal efficiency of the heat exchanger and sound emission at different operating points. More details about measurements done are collected in the next paragraphs.

6.1. Performance data

The diagrams show the available external pressure for the duct system given the airflow.

The SFPv (Specific Fan Power [$\text{W}/\text{m}^3/\text{s}$]) curves are referring to the complete unit. Moreover, it includes power to both supply and extract fans divided by either the supply or extract volume, whichever is the greatest.

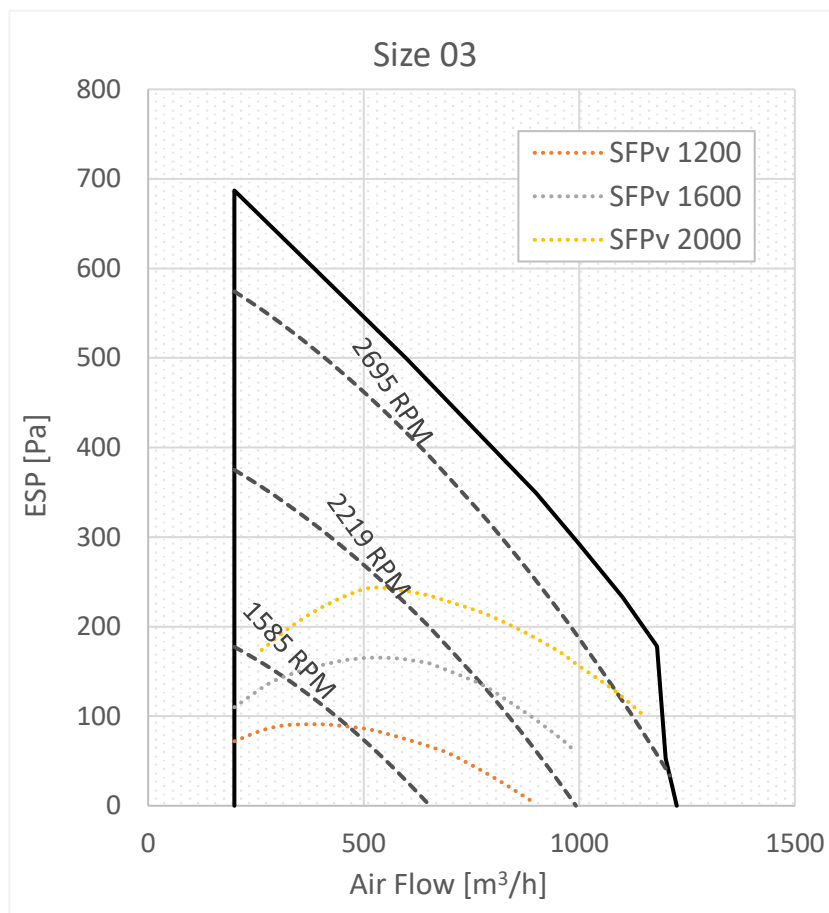

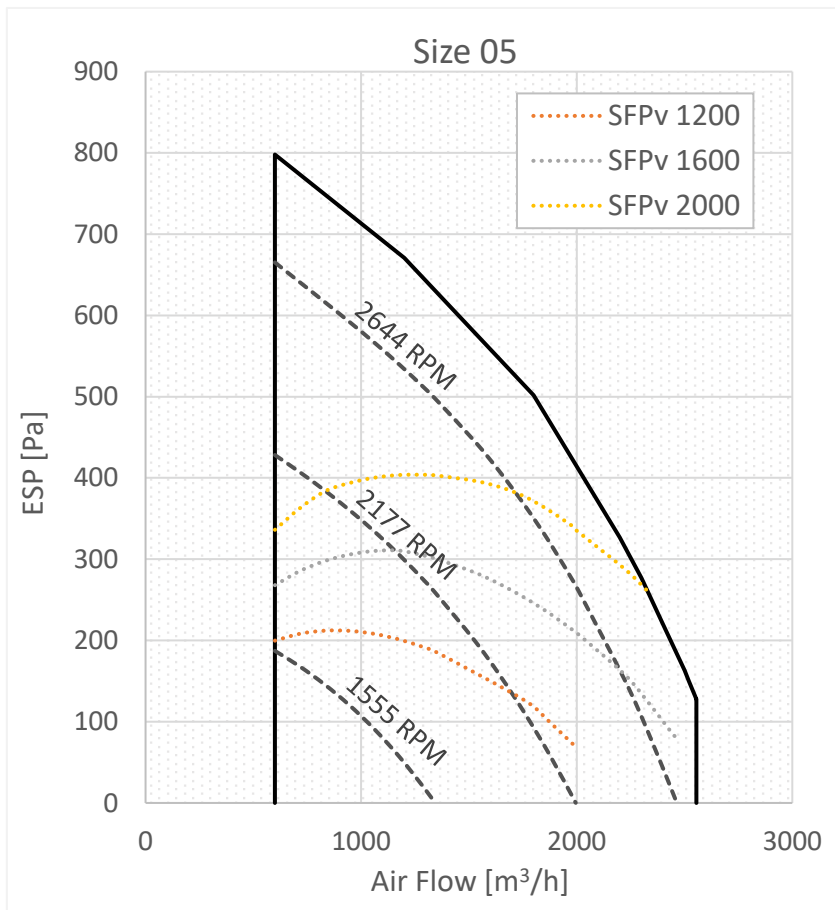
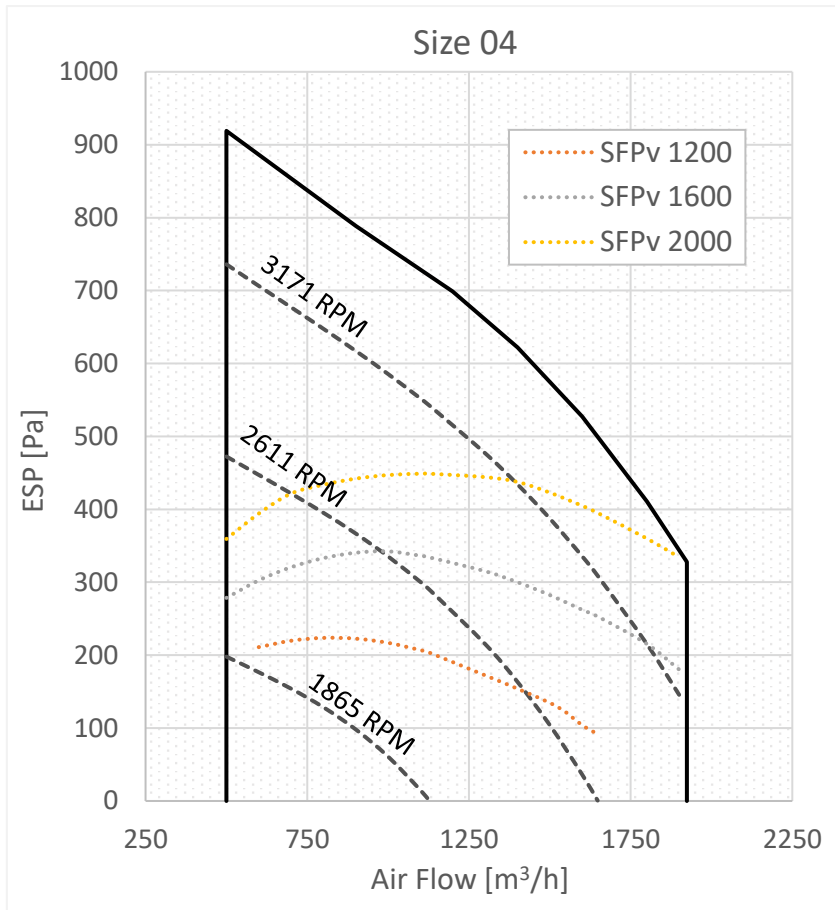

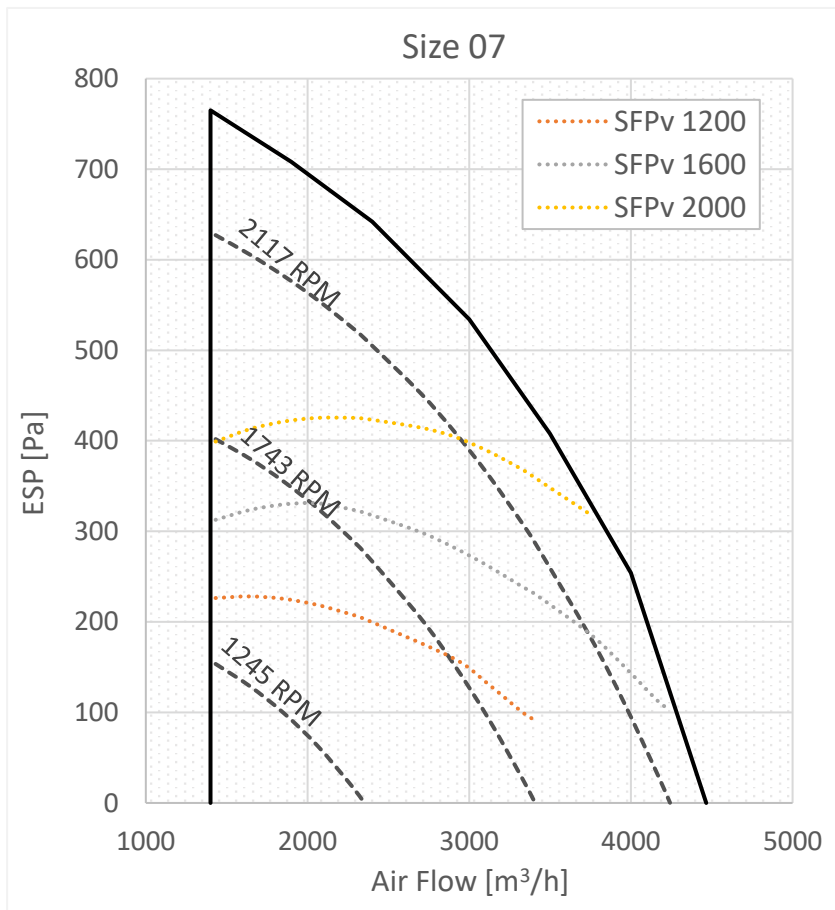
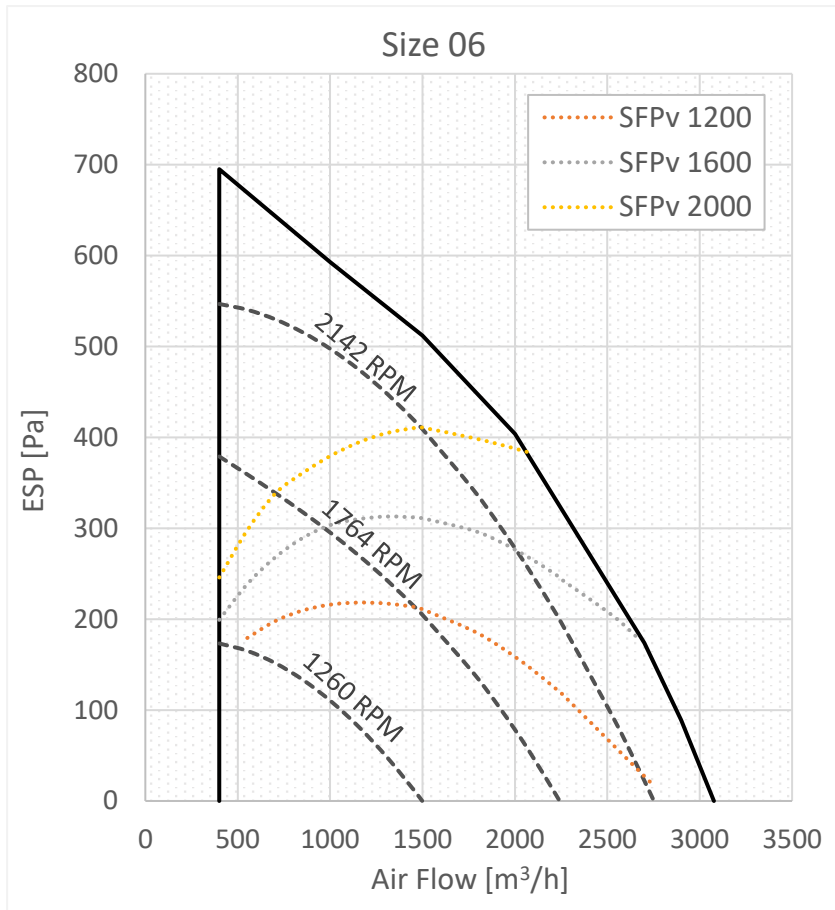

6.2. Thermal efficiency

The charts indicate the thermal efficiency of the heat exchanger at the following conditions:

- Wet efficiency: -5°C/ RH 90% Outdoor and +22°C/50% Indoor
- With air ratio 1:1 and according to EN308

Thermal efficiency: Size 03

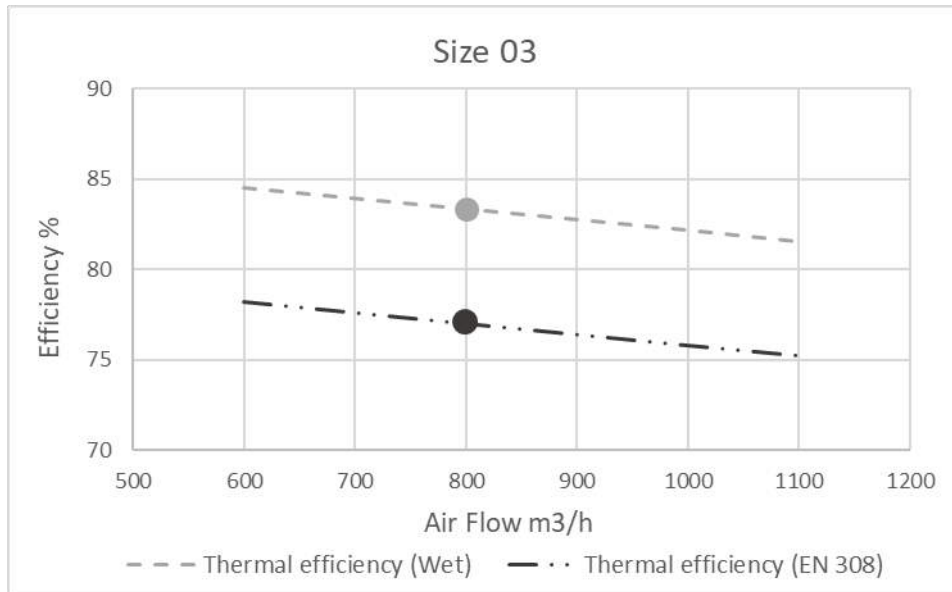

Thermal efficiency: Size 04

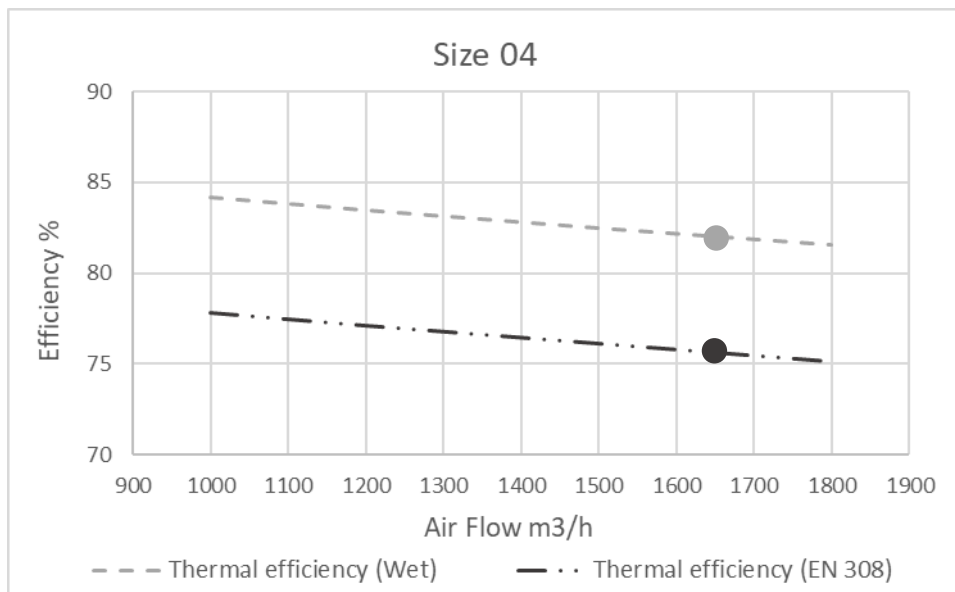

Thermal efficiency: Size 05

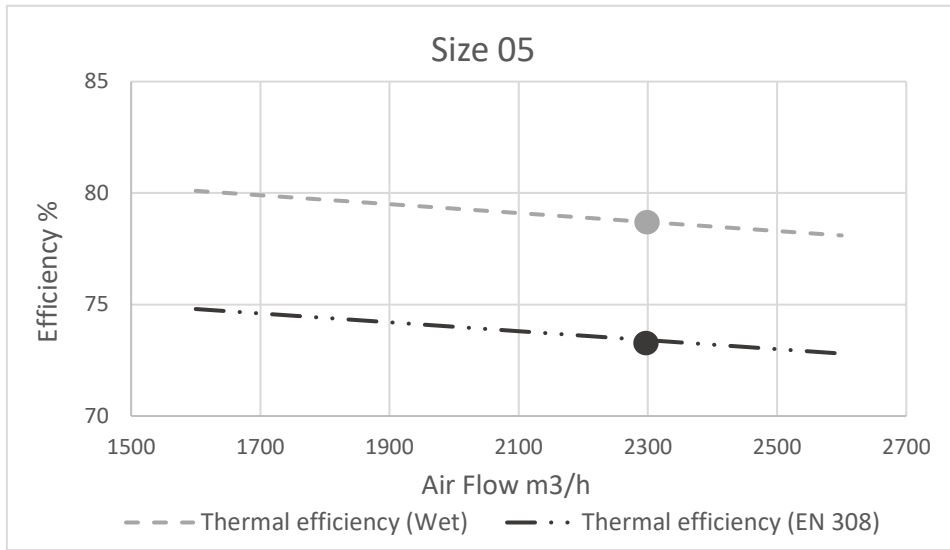

Thermal efficiency: Size 06

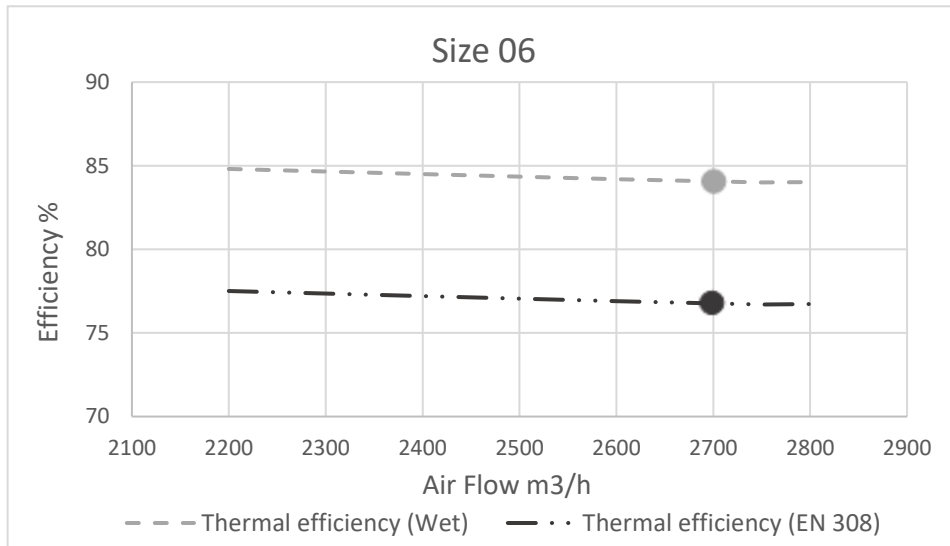

Thermal efficiency: Size 07

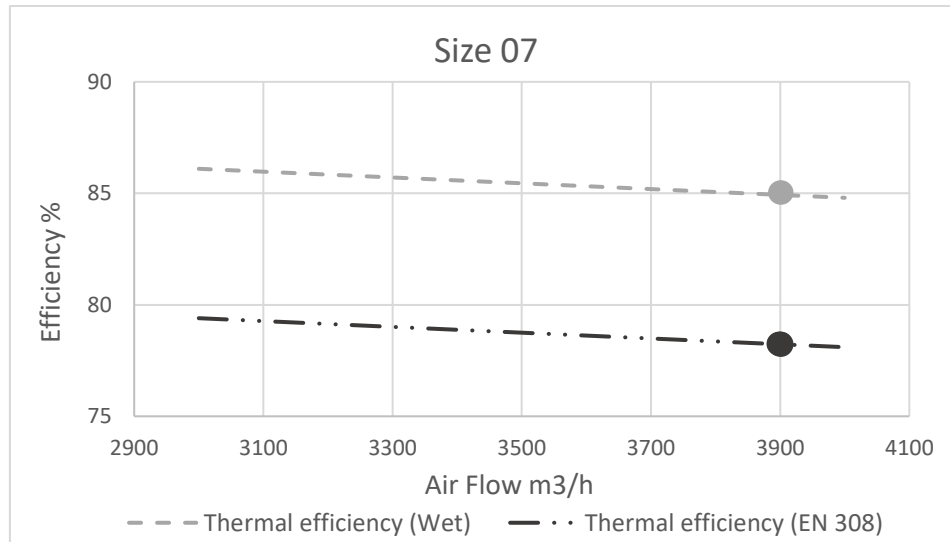

6.3. Sound emission

Surrounding power level: The airborne is the sound power emitted by the unit. The surrounding power level is the logarithmic sum of the two airborne values (supply and return).

Surrounding pressure level: It is calculated in accordance with EN3744. The evaluation is done at 1 meter from the source and with a directivity factor equal to 4, in non-reverberant field.

Sound Level Size O3

Air flow: 600 m³/h, ESP: 50 Pa

Point A	Frequency (Hz)	63	125	250	500	1000	2000	4000	8000	Avg (dBA)
Sound power (dB)	Supply inlet	66	72	55	42	39	36	23	12	57
	Supply outlet	65	78	67	62	58	58	49	42	66
	Return inlet	65	72	54	42	39	35	23	12	56
	Return outlet	65	78	67	62	57	57	49	42	66
	Surrounding power	68	69	50	44	37	35	27	16	54
Surrounding pressure (dBA)										47

Air flow: 1000 m³/h, ESP: 50 Pa

Point B	Frequency (Hz)	63	125	250	500	1000	2000	4000	8000	Avg (dBA)
Sound power (dB)	Supply inlet	61	69	64	46	45	41	30	21	57
	Supply outlet	62	76	81	67	64	64	57	51	74
	Return inlet	61	69	64	45	45	41	30	21	57
	Return outlet	62	76	81	67	64	63	57	51	74
	Surrounding power	65	67	64	49	44	41	34	24	57
Surrounding pressure (dBA)										50

Air flow: 600 m³/h, ESP: 150 Pa

Point C	Frequency (Hz)	63	125	250	500	1000	2000	4000	8000	Avg (dBA)
Sound power (dB)	Supply inlet	73	74	62	48	44	40	28	17	59
	Supply outlet	72	79	75	67	62	63	55	48	71
	Return inlet	73	73	62	47	44	40	28	17	59
	Return outlet	72	79	75	67	62	63	54	48	71
	Surrounding power	75	70	58	50	42	40	32	21	57
Surrounding pressure (dBA)										50

Air flow: 1000 m³/h, ESP: 150 Pa

Point D	Frequency (Hz)	63	125	250	500	1000	2000	4000	8000	Avg (dBA)
Sound power (dB)	Supply inlet	66	70	68	49	47	43	32	24	60
	Supply outlet	68	76	85	70	66	66	59	54	77
	Return inlet	66	70	68	49	47	43	32	24	60
	Return outlet	67	76	85	69	66	66	59	54	77
	Surrounding power	71	67	68	52	46	43	37	27	60
Surrounding pressure (dBA)										53

Allowances on declared data: +/- 3 dB(A)

Sound Level Size 04

Air flow: 1200 m³/h, ESP: 50 Pa

Point A	Frequency (Hz)	63	125	250	500	1000	2000	4000	8000	Avg (dBA)
Sound power (dB)	Supply inlet	50	58	55	43	42	36	28	20	49
	Supply outlet	52	65	67	62	59	60	54	49	66
	Return inlet	52	57	51	41	41	37	27	19	48
	Return outlet	53	64	67	63	61	61	54	49	67
	Surrounding power	56	56	50	45	41	38	32	23	48
Surrounding pressure (dBA)										41

Air flow: 1500 m³/h, ESP: 50 Pa

Point B	Frequency (Hz)	63	125	250	500	1000	2000	4000	8000	Avg (dBA)
Sound power (dB)	Supply inlet	54	54	57	45	46	40	32	26	51
	Supply outlet	56	60	71	64	62	64	59	55	70
	Return inlet	56	53	56	44	44	40	31	24	51
	Return outlet	58	60	71	66	65	64	58	54	70
	Surrounding power	61	51	54	48	44	42	36	28	51
Surrounding pressure (dBA)										44

Air flow: 1200 m³/h, ESP: 150 Pa

Point C	Frequency (Hz)	63	125	250	500	1000	2000	4000	8000	Avg (dBA)
Sound power (dB)	Supply inlet	54	61	60	45	45	39	29	22	53
	Supply outlet	56	68	74	64	61	63	57	52	69
	Return inlet	56	62	660	44	44	40	29	21	53
	Return outlet	57	69	76	65	63	63	56	51	71
	Surrounding power	60	60	58	47	42	40	34	25	53
Surrounding pressure (dBA)										46

Air flow: 1500 m³/h, ESP: 150 Pa

Point D	Frequency (Hz)	63	125	250	500	1000	2000	4000	8000	Avg (dBA)
Sound power (dB)	Supply inlet	58	53	60	46	47	42	32	26	53
	Supply outlet	60	60	74	66	64	66	60	56	71
	Return inlet	62	54	58	45	46	42	32	24	53
	Return outlet	65	61	73	67	66	66	60	55	72
	Surrounding power	67	52	57	49	46	43	38	29	53
Surrounding pressure (dBA)										46

Allowances on declared data: +/- 3 dB(A)

Sound Level Size 05

Air flow: 2100 m³/h, ESP: 50 Pa

Point A	Frequency (Hz)	63	125	250	500	1000	2000	4000	8000	Avg (dBA)
Sound power (dB)	Supply inlet	61	62	60	47	45	42	33	29	54
	Supply outlet	62	66	73	68	65	65	59	57	71
	Return inlet	61	62	60	47	45	42	33	29	54
	Return outlet	62	66	73	68	64	65	59	57	71
	Surrounding power	65	57	56	50	44	43	37	30	52
Surrounding pressure (dBA)										45

Air flow: 2500 m³/h, ESP: 50 Pa

Point B	Frequency (Hz)	63	125	250	500	1000	2000	4000	8000	Avg (dBA)
Sound power (dB)	Supply inlet	66	65	62	50	48	45	36	34	57
	Supply outlet	68	69	77	71	68	68	62	62	75
	Return inlet	66	65	62	50	48	45	36	34	57
	Return outlet	68	69	77	71	68	68	62	62	75
	Surrounding power	71	60	60	53	48	45	40	35	56
Surrounding pressure (dBA)										49

Air flow: 2100 m³/h, ESP: 150 Pa

Point C	Frequency (Hz)	63	125	250	500	1000	2000	4000	8000	Avg (dBA)
Sound power (dB)	Supply inlet	62	64	63	49	46	43	34	29	56
	Supply outlet	64	68	75	69	66	66	60	57	73
	Return inlet	62	64	63	49	46	43	34	29	56
	Return outlet	64	68	75	69	66	66	60	57	73
	Surrounding power	67	59	58	51	46	43	38	31	54
Surrounding pressure (dBA)										47

Air flow: 2500 m³/h, ESP: 150 Pa

Point D	Frequency (Hz)	63	125	250	500	1000	2000	4000	8000	Avg (dBA)
Sound power (dB)	Supply inlet	68	63	63	51	50	46	37	33	57
	Supply outlet	71	68	78	71	69	69	63	62	76
	Return inlet	67	63	63	51	50	46	37	33	57
	Return outlet	71	68	78	71	69	69	63	62	76
	Surrounding power	74	59	60	54	49	47	41	35	57
Surrounding pressure (dBA)										50

Allowances on declared data: +/- 3 dB(A)

Sound Level Size 06

Air flow: 2600 m³/h, ESP: 50 Pa

Point A	Frequency (Hz)	63	125	250	500	1000	2000	4000	8000	Avg (dBA)
Sound power (dB)	Supply inlet	61	62	56	47	44	41	32	26	52
	Supply outlet	62	70	73	70	64	65	59	55	72
	Return inlet	62	62	56	47	44	41	32	26	52
	Return outlet	63	70	73	70	64	64	59	55	72
	Surrounding power	66	61	56	52	43	42	37	29	53
Surrounding pressure (dBA)										46

Air flow: 2750 m³/h, ESP: 50 Pa

Point B	Frequency (Hz)	63	125	250	500	1000	2000	4000	8000	Avg (dBA)
Sound power (dB)	Supply inlet	63	62	58	48	46	42	33	27	54
	Supply outlet	64	70	76	70	65	66	60	57	73
	Return inlet	63	62	58	48	46	42	33	27	54
	Return outlet	64	70	75	70	65	66	60	57	73
	Surrounding power	67	61	58	53	45	43	38	30	55
Surrounding pressure (dBA)										48

Air flow: 2600 m³/h, ESP: 150 Pa

Point C	Frequency (Hz)	63	125	250	500	1000	2000	4000	8000	Avg (dBA)
Sound power (dB)	Supply inlet	60	62	59	48	47	42	32	26	54
	Supply outlet	62	70	77	71	65	66	60	56	73
	Return inlet	60	62	59	48	47	42	32	26	54
	Return outlet	62	70	76	71	65	66	60	56	73
	Surrounding power	65	61	59	53	45	43	38	29	55
Surrounding pressure (dBA)										48

Air flow: 2750 m³/h, ESP: 150 Pa

Point D	Frequency (Hz)	63	125	250	500	1000	2000	4000	8000	Avg (dBA)
Sound power (dB)	Supply inlet	62	61	61	49	48	43	33	27	55
	Supply outlet	64	69	79	71	66	67	61	57	75
	Return inlet	62	61	61	49	48	43	33	27	55
	Return outlet	64	69	78	71	66	67	61	57	74
	Surrounding power	67	60	61	54	44	44	39	31	56
Surrounding pressure (dBA)										49

Allowances on declared data: +/- 3 dB(A)

Sound Level Size 07

Air flow: 3000 m³/h, ESP: 50 Pa

Point A	Frequency (Hz)	63	125	250	500	1000	2000	4000	8000	Avg (dBA)
Sound power (dB)	Supply inlet	63	67	56	44	42	39	30	23	53
	Supply outlet	64	73	68	67	61	64	58	54	70
	Return inlet	63	67	56	44	41	39	30	23	53
	Return outlet	64	72	68	67	61	64	58	53	69
	Surrounding power	67	64	51	49	41	41	35	27	52
Surrounding pressure (dBA)										45

Air flow: 4000 m³/h, ESP: 50 Pa

Point B	Frequency (Hz)	63	125	250	500	1000	2000	4000	8000	Avg (dBA)
Sound power (dB)	Supply inlet	72	69	65	53	47	45	36	31	59
	Supply outlet	72	76	79	73	67	69	64	62	76
	Return inlet	72	69	65	53	47	45	36	31	59
	Return outlet	72	76	79	73	67	69	64	62	76
	Surrounding power	75	67	61	55	47	47	42	35	58
Surrounding pressure (dBA)										51

Air flow: 3000 m³/h, ESP: 150 Pa

Point C	Frequency (Hz)	63	125	250	500	1000	2000	4000	8000	Avg (dBA)
Sound power (dB)	Supply inlet	61	69	57	46	43	41	30	24	55
	Supply outlet	63	75	70	69	63	66	59	55	71
	Return inlet	61	69	57	46	43	41	30	24	55
	Return outlet	63	75	70	69	63	65	59	55	71
	Surrounding power	66	66	53	51	43	43	37	28	54
Surrounding pressure (dBA)										47

Air flow: 4000 m³/h, ESP: 150 Pa

Point D	Frequency (Hz)	63	125	250	500	1000	2000	4000	8000	Avg (dBA)
Sound power (dB)	Supply inlet	70	69	66	53	48	46	36	31	59
	Supply outlet	70	76	80	74	68	71	65	62	77
	Return inlet	70	69	66	53	48	46	36	31	59
	Return outlet	70	76	80	74	68	71	65	62	77
	Surrounding power	73	67	59	56	48	48	43	35	59
Surrounding pressure (dBA)										56

Allowances on declared data: +/- 3 dB(A)

Dimension Drawing: Size 05

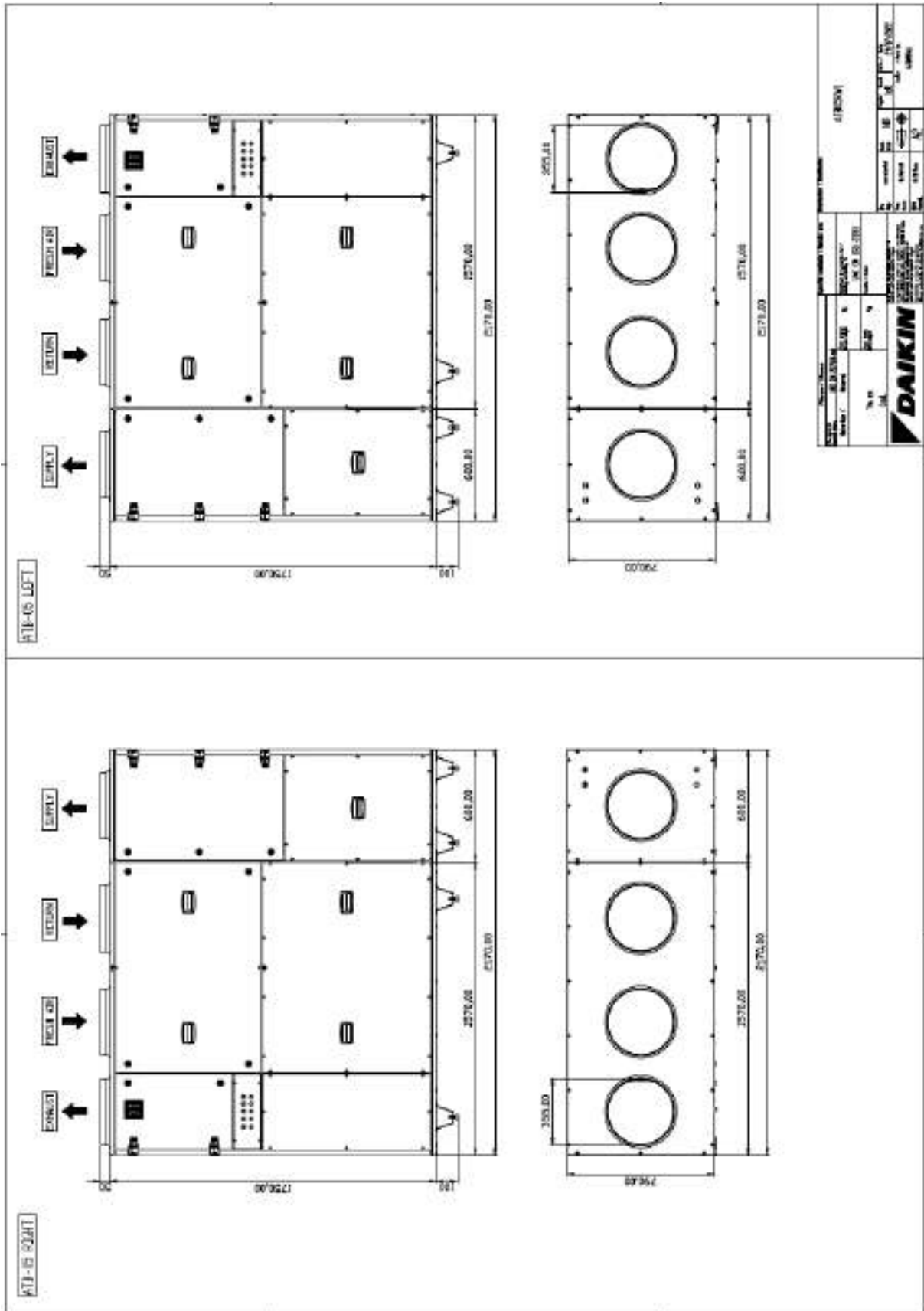

Dimension Drawing: Size 06

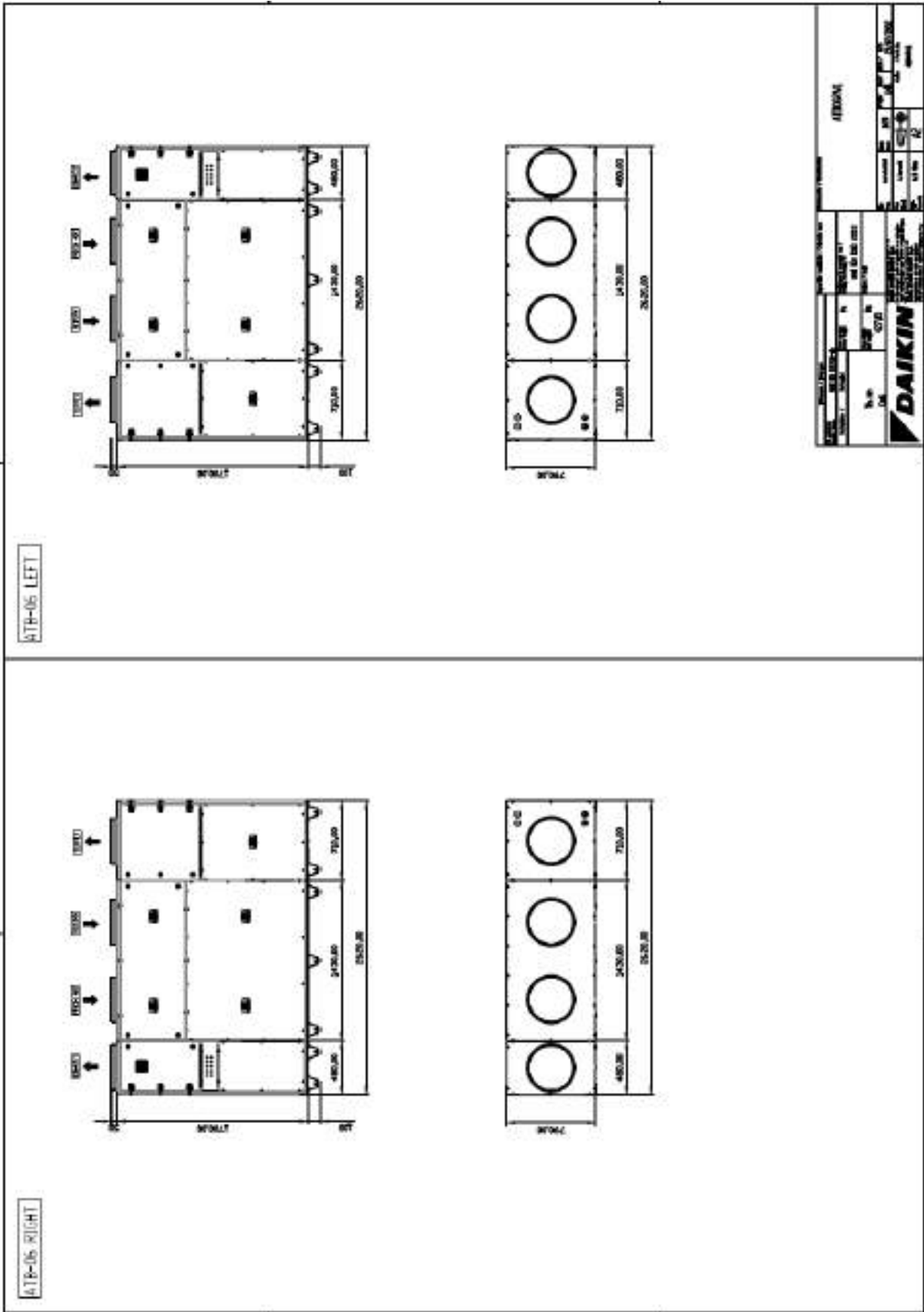

All the technical data and performances included within this document are subject to change without prior notice. Please refer to the last version of selection software available online for updated information (tools.daikinapplied.eu)